

FCC Information and Copyright

This equipment has been tested and found to comply with the limits of a Class B digital device, pursuant to Part 15 of the FCC Rules. These limits are designed to provide reasonable protection against harmful interference in a residential installation. This equipment generates, uses, and can radiate radio frequency energy and, if not installed and used in accordance with the instructions, may cause harmful interference to radio communications. There is no guarantee that interference will not occur in a particular installation.

The vendor makes no representations or warranties with respect to the contents here and specially disclaims any implied warranties of merchantability or fitness for any purpose. Further the vendor reserves the right to revise this publication and to make changes to the contents here without obligation to notify any party beforehand.

Duplication of this publication, in part or in whole, is not allowed without first obtaining the vendor's approval in writing.

The content of this user's manual is subject to be changed without notice and we will not be responsible for any mistakes found in this user's manual. All the brand and product names are trademarks of their respective companies.



Dichiarazione di conformità sintetica

Ai sensi dell'art. 2 comma 3 del D.M. 275 del 30/10/2002

Si dichiara che questo prodotto è conforme alle normative vigenti e soddisfa i requisiti essenziali richiesti dalle direttive

2004/108/CE, 2006/95/CE e 1999/05/CE

quando ad esso applicabili

Short Declaration of conformity

We declare this product is complying with the laws in force and meeting all the essential requirements as specified by the directives

2004/108/CE, 2006/95/CE and 1999/05/CE

whenever these laws may be applied

Table of Contents

Chapter 1: Introduction	1
1.1 Before You Start	1
1.2 Package Checklist	1
1.3 Motherboard Specifications	2
1.4 Rear Panel Connectors	4
1.5 Motherboard Layout.....	5
Chapter 2: Hardware Installation	6
2.1 Install Central Processing Unit (CPU).....	6
2.2 Install a Heatsink	8
2.3 Connect Cooling Fans	9
2.4 Install System Memory	10
2.5 Expansion Slots.....	11
2.6 Jumper Setting	13
2.7 Headers & Connectors	14
2.8 Smart Switches & Indicators.....	19
Chapter 3: UEFI BIOS & Software	20
3.1 UEFI BIOS Setup	20
3.2 BIOS Update.....	20
3.3 Software.....	24
Chapter 4: Useful Help	37
4.1 Driver Installation.....	38
4.2 AMI BIOS Beep Code.....	39
4.3 AMI BIOS Post Code.....	39
4.4 Troubleshooting.....	41
4.5 RAID Functions	42
Appendix: Specifications in Other Languages	44
Arabic.....	44
French	46
German	48
Italian	50
Japanese.....	52
Polish	54
Portuguese	56
Russian	58
Spanish.....	60

CHAPTER 1: INTRODUCTION

1.1 Before You Start

Thank you for choosing our product. Before you start installing the motherboard, please make sure you follow the instructions below:

- Prepare a dry and stable working environment with sufficient lighting.
- Always disconnect the computer from power outlet before operation.
- Before you take the motherboard out from anti-static bag, ground yourself properly by touching any safely grounded appliance, or use grounded wrist strap to remove the static charge.
- Avoid touching the components on motherboard or the rear side of the board unless necessary. Hold the board on the edge, do not try to bend or flex the board.
- Do not leave any unfastened small parts inside the case after installation. Loose parts will cause short circuits which may damage the equipment.
- Keep the computer from dangerous area, such as heat source, humid air and water.
- The operating temperatures of the computer should be 0 to 45 degrees Celsius.
- To avoid injury, be careful of:
 - Sharp pins on headers and connectors
 - Rough edges and sharp corners on the chassis
 - Damage to wires that could cause a short circuit

1.2 Package Checklist

- Serial ATA Cable x4
- Rear I/O Panel for ATX Case x1
- User's Manual x1
- Fully Setup Driver DVD x1

Note: The package contents may be different due to the sales region or models in which it was sold. For more information about the standard package in your region, please contact your dealer or sales representative.

Hi-Fi Z87W 3D/Hi-Fi H87W 3D/Hi-Fi B85W 3D

Specifications			
	Hi-Fi Z87W 3D & Hi-Fi H87W 3D	Hi-Fi B85W 3D	
Internal I/Os	6x SATA 6.0Gb/s Connector	4x SATA 6.0Gb/s Connector	
	2x USB 2.0 Header (each header supports 2 USB 2.0 ports)	2x SATA 3.0Gb/s Connector	
	1x USB 3.0 Header (each header supports 2 USB 3.0 ports)	2x USB 2.0 Header (each header supports 2 USB 2.0 ports)	
	1x 8-Pin Power Connector	1x USB 3.0 Header (each header supports 2 USB 3.0 ports)	
	1x 24-Pin Power Connector	1x 8-Pin Power Connector	
	1x CPU Fan Connector	1x 24-Pin Power Connector	
	4x System Fan Connector	1x CPU Fan Connector	
	1x Front Panel Header	4x System Fan Connector	
	1x Front Audio Header	1x Front Panel Header	
	1x Clear CMOS Header	1x Front Audio Header	
	1x Consumer IR Header	1x Clear CMOS Header	
	1x Serial Port Header	1x Consumer IR Header	
	1x S/PDIF out Connector	1x Serial Port Header	
			1x S/PDIF out Connector
	Form Factor	ATX Form Factor, 305 mm x 220 mm	
OS Support	Windows 7/ 8 Biostar reserves the right to add or remove support for any OS with or without notice.		

1.4 Rear Panel Connectors

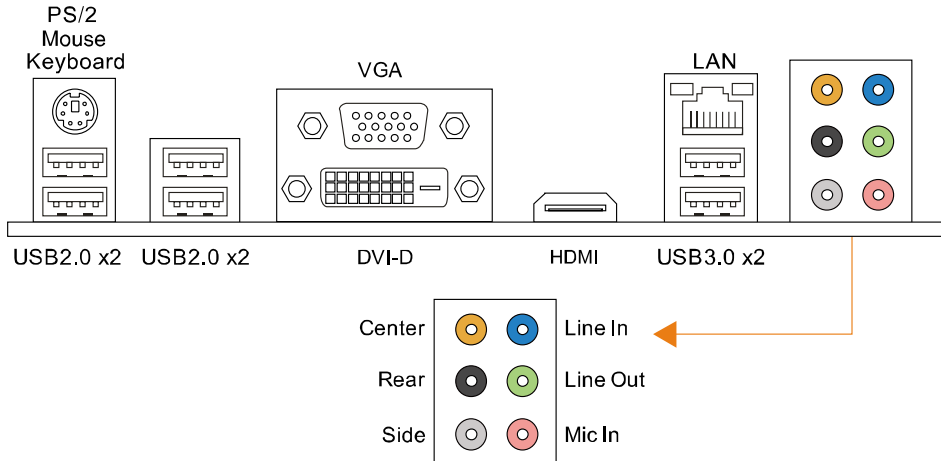

Note1: HDMI, DVI-D & VGA ports only work with an Intel® integrated Graphics Processor.

Note2: Maximum resolution:
HDMI: 4096 x 2160 @24Hz, compliant with HDMI 1.4a
DVI: 1920 x 1200 @60Hz
VGA: 1920 x 1200 @60Hz

Note3: The mainboard supports three onboard display outputs at same time.

1.5 Motherboard Layout

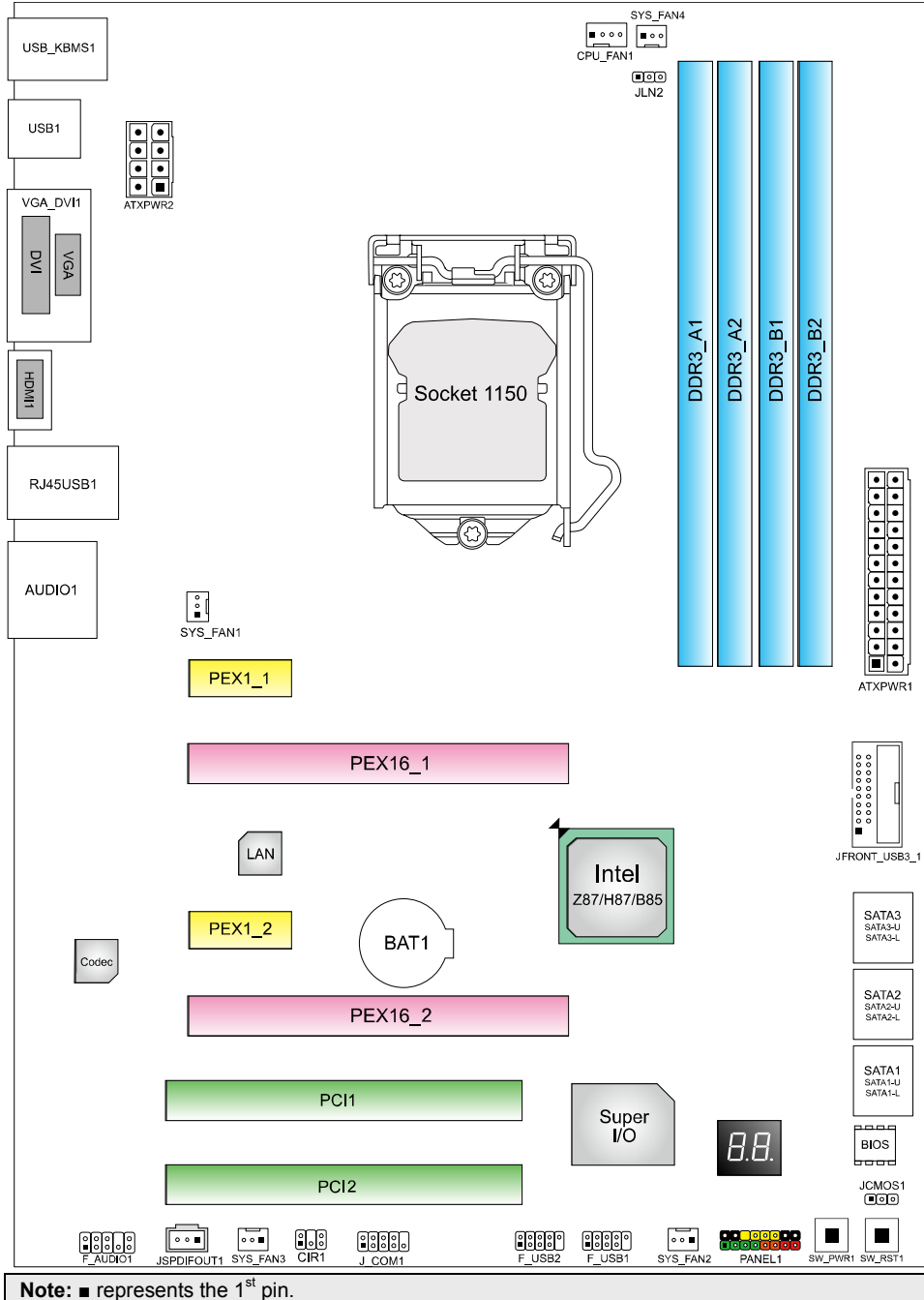

CHAPTER 2: HARDWARE INSTALLATION

2.1 Install Central Processing Unit (CPU)

Step 1: Locate the CPU socket on the motherboard

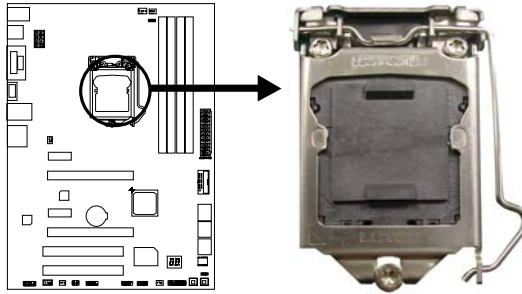

Note1: Remove Pin Cap before installation, and make good preservation for future use. When the CPU is removed, cover the Pin Cap on the empty socket to ensure pin legs won't be damaged.
Note2: The motherboard might equip with two different types of pin cap. Please refer below instruction to remove the pin cap.

Step 2: Pull the socket locking lever out from the socket and then raise the lever up.

Type A

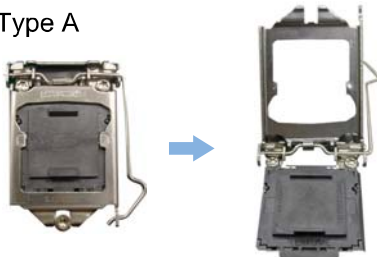

Type B

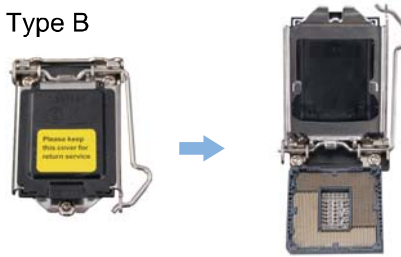

Step 3: Remove the Pin Cap.

Type A

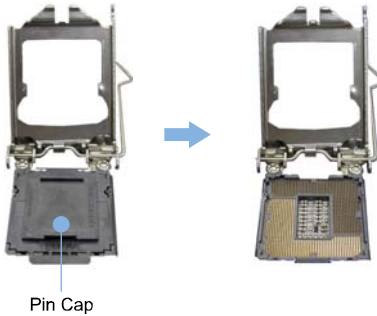

Type B

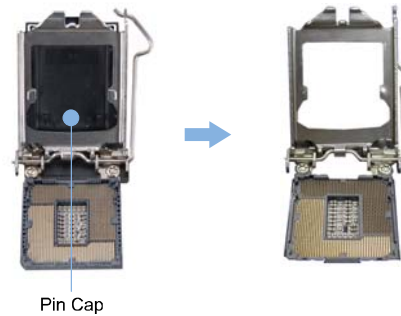

Hi-Fi Z87W 3D/Hi-Fi H87W 3D/Hi-Fi B85W 3D

Step 4: Hold processor with your thumb and index fingers, oriented as shown. Align the notches with the socket. Lower the processor straight down without tilting or sliding the processor in the socket.



Note1: The LGA1155 CPU is not compatible with LGA 1150 socket. Do not install a LGA 1155 CPU on the LGA 1150 socket.
Note2: The CPU fits only in one correct orientation. Do not force the CPU into the socket to prevent damaging the CPU.

Step 5: Hold the CPU down firmly, and then lower the lever to locked position to complete the installation.



2.2 Install a Heatsink

Step 1: Place the CPU fan assembly on top of the installed CPU and make sure that the four fasteners match the motherboard holes. Orient the assembly and make the fan cable is closest to the CPU fan connector. Ensure the fastener slots are pointing perpendicular to the heatsink.

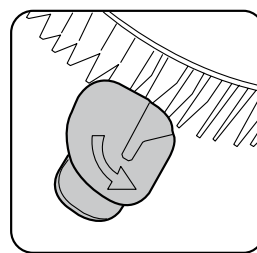

Correct Orientation

Step 2: Press down two fasteners at one time in a diagonal sequence to secure the CPU fan assembly in place. As each fastener locks into position a click should be heard.

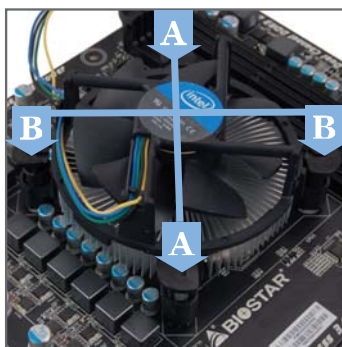

Note1: Do not forget to connect the CPU fan connector.

Note2: For proper installation, please kindly refer to the installation manual of your CPU heatsink.

2.3 Connect Cooling Fans

These fan headers support cooling-fans built in the computer. The fan cable and connector may be different according to the fan manufacturer.

CPU_FAN1: CPU Fan Header

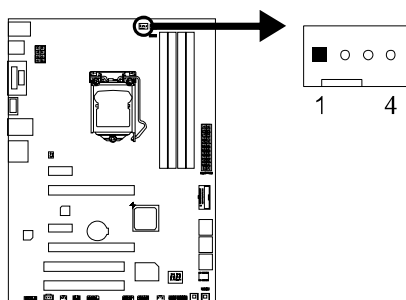

Pin	Assignment
1	Ground
2	+12V
3	FAN RPM rate sense
4	Smart Fan Control (By Fan)

SYS_FAN1/2/3/4: System Fan Header

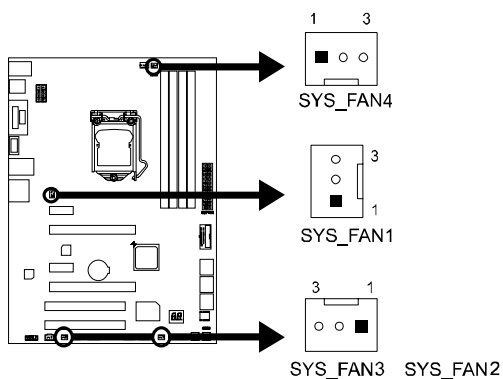

Pin	Assignment
1	Ground
2	+12V
3	FAN RPM rate sense

Note: CPU_FAN1, SYS_FAN1/2/3/4 support 4-pin and 3-pin head connectors. When connecting with wires onto connectors, please note that the red wire is the positive and should be connected to pin#2, and the black wire is Ground and should be connected to pin#1(GND).

2.4 Install System Memory

DDR3 Modules

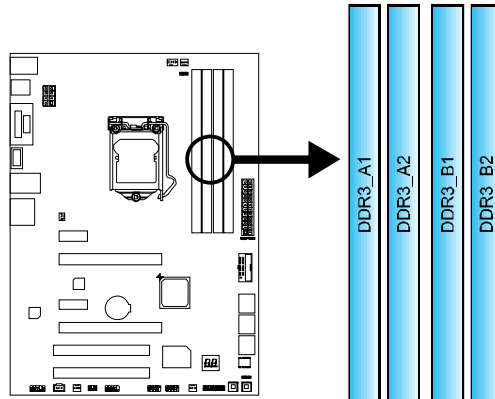

Step 1: Unlock a DIMM slot by pressing the retaining clips outward. Align a DIMM on the slot such that the notch on the DIMM matches the break on the slot.

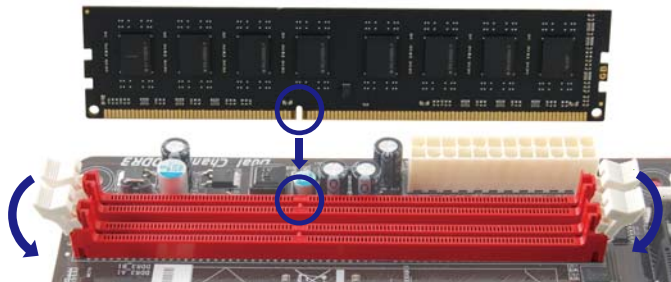

Step 2: Insert the DIMM vertically and firmly into the slot until the retaining clips snap back in place and the DIMM is properly seated.

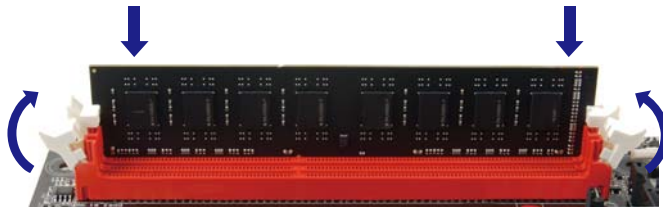

Note: If the DIMM does not go in smoothly, do not force it. Pull it all the way out and try again.

Memory Capacity

DIMM Socket Location	DDR3 Module	Total Memory Size
DDR3_A1	512MB/1GB/2GB/4GB/8GB	Max is 32GB.
DDR3_A2	512MB/1GB/2GB/4GB/8GB	
DDR3_B1	512MB/1GB/2GB/4GB/8GB	
DDR3_B2	512MB/1GB/2GB/4GB/8GB	

Dual Channel Memory Installation

Please refer to the following requirements to activate Dual Channel function:
Install memory module of the same density in pairs, shown in the table.

Dual Channel Status	DDR3_A1	DDR3_A2	DDR3_B1	DDR3_B2
Enabled	O	X	O	X
Enabled	X	O	X	O
Enabled	O	O	O	O

(O means memory installed, X means memory not installed.)

Note: The DRAM bus width of the memory module must be the same (x8 or x16)

2.5 Expansion Slots

Install an Expansion Card

You can install your expansion card by following steps:

1. Read the related expansion card's instruction document before install the expansion card into the computer.
2. Remove your computer's chassis cover, screws and slot bracket from the computer.
3. Place a card in the expansion slot and press down on the card until it is completely seated in the slot.
4. Secure the card's metal bracket to the chassis back panel with a screw.
5. Replace your computer's chassis cover.
6. Power on the computer, if necessary, change BIOS settings for the expansion card.
7. Install related driver for the expansion card.

PEX16_1: PCI-Express Gen3 x16 Slot

- PCI-Express 3.0 compliant.
- Maximum theoretical realized bandwidth of 16GB/s simultaneously per direction, for an aggregate of 32GB/s totally.

PEX16_2: PCI-Express Gen2 x4 Slot

- PCI-Express 2.0 compliant.
- Maximum theoretical realized bandwidth of 2GB/s simultaneously per direction, for an aggregate of 4GB/s totally.

PEX1_1/1_2: PCI-Express Gen2 x1 Slots

- PCI-Express 2.0 compliant.
- Data transfer bandwidth up to 500MB/s per direction; 1GB/s in total

PCI1/ PCI2: Peripheral Component Interconnect Slots

- The PCI slots support cards used in PCs include: LAN cards, sound cards, modems, TV tuner cards and other cards that comply PCI standard.

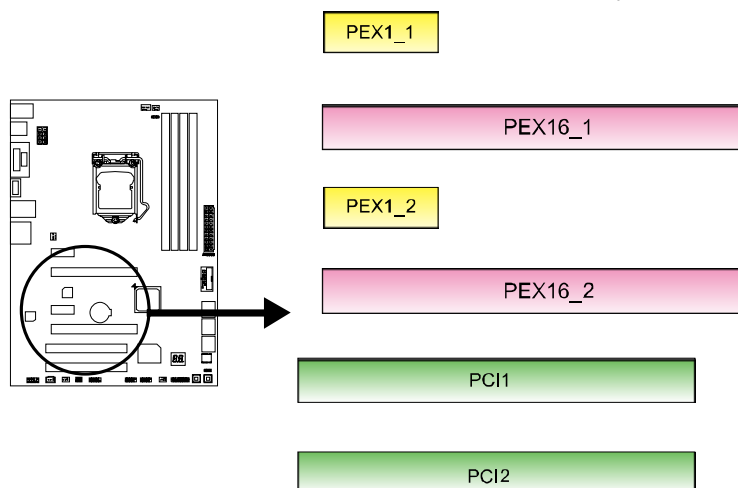

2.6 Jumper Setting

The illustration shows how to set up jumpers. When the jumper cap is placed on pins, the jumper is “close”, if not, that means the jumper is “open”.



JCMOS1: Clear CMOS Jumper

Placing the jumper on pin2-3, it allows user to restore the BIOS safe setting and the CMOS data. Please carefully follow the procedures to avoid damaging the motherboard.

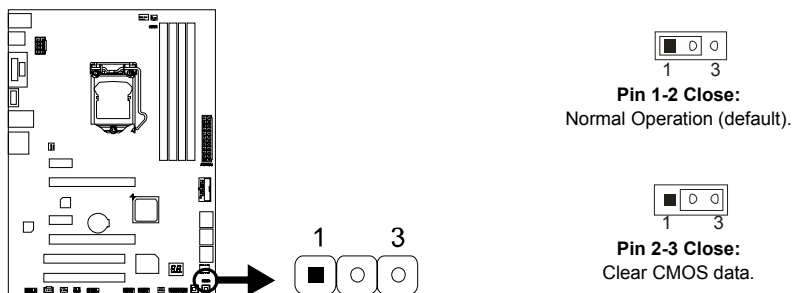

※ Clear CMOS Procedures:

1. Remove AC power line.
2. Set the jumper to “Pin 2-3 close”.
3. Wait for five seconds.
4. Set the jumper to “Pin 1-2 close”.
5. Power on the AC.
6. Load Optimal Defaults and save settings in CMOS.

JLN2: LN2 Mode Jumper

When the LN2 mode is enabled, the motherboard can boot at an extremely low temperature (-130°C)

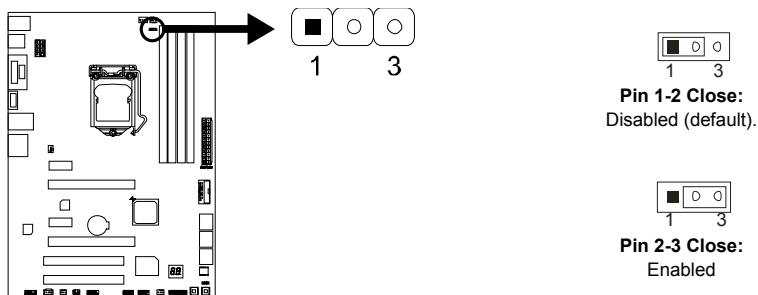

2.7 Headers & Connectors

ATXPWR1: ATX Power Source Connector

For better compatibility, we recommend to use a standard ATX 24-pin power supply for this connector. Make sure to find the correct orientation before plugging the connector.

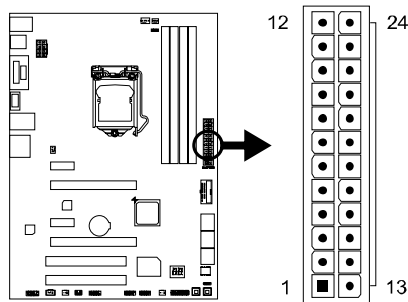

Pin	Assignment	Pin	Assignment
13	+3.3V	1	+3.3V
14	-12V	2	+3.3V
15	Ground	3	Ground
16	PS_ON	4	+5V
17	Ground	5	Ground
18	Ground	6	+5V
19	Ground	7	Ground
20	NC	8	PW_OK
21	+5V	9	Standby Voltage+5V
22	+5V	10	+12V
23	+5V	11	+12V
24	Ground	12	+3.3V

ATXPWR2: ATX Power Source Connector

The connector provides +12V to the CPU power circuit. If the CPU power plug is 4-pin, please plug it into Pin 1-2-5-6 of ATXPWR2.

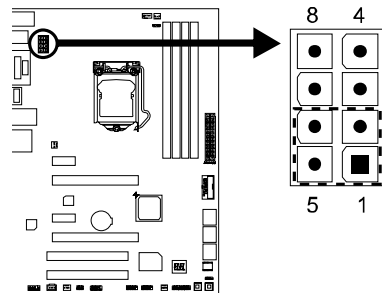

Pin	Assignment
1	+12V
2	+12V
3	+12V
4	+12V
5	Ground
6	Ground
7	Ground
8	Ground

Note1: Before you power on the system, please make sure that both ATXPWR1 and ATXPWR2 connectors have been plugged-in.

Note2: Insufficient power supplied to the system may result in instability or the peripherals not functioning properly. Use of a PSU with a higher power output is recommended when configuring a system with more power-consuming devices.

PANEL1: Front Panel Header

This 16-pin header includes Power-on, Reset, HDD LED, Power LED, and speaker connection. It allows user to connect the PC case's front panel switch functions.

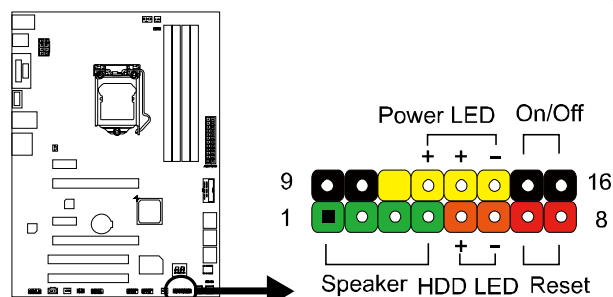

Pin	Assignment	Function	Pin	Assignment	Function
1	+5V		9	N/A	N/A
2	N/A	Speaker Connector	10	N/A	N/A
3	N/A		11	N/A	N/A
4	Speaker		12	Power LED (+)	Power LED
5	HDD LED (+)	13	Power LED (+)		
6	HDD LED (-)	14	Power LED (-)		
7	Ground	Reset button	15	Power button	Power-on button
8	Reset control		16	Ground	

SATA1~SATA3: Serial ATA Connectors

These connectors connect to SATA hard disk drives via SATA cables. Please refer below table for SATA data transfer rates.

Connectors Models	SATA1-U	SATA1-L	SATA2-U	SATA2-L	SATA3-U	SATA3-L
	Hi-Fi Z87W 3D	SATA 6Gb/s				
Hi-Fi H87W 3D	SATA 6Gb/s					
Hi-Fi B85W 3D	SATA 6Gb/s				SATA 3Gb/s	

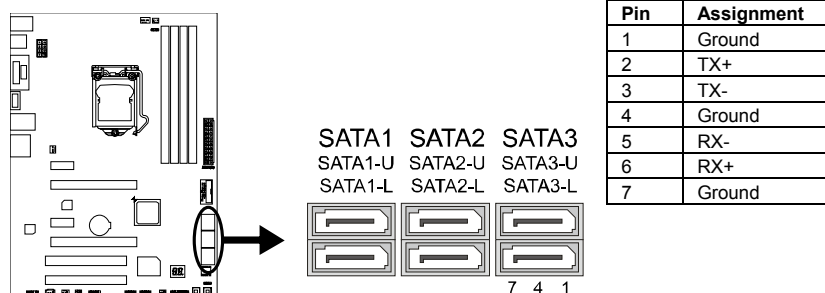

JFRONT_USB3_1: Header for USB 3.0 Ports at Front Panel

This header allows user to add additional USB ports on the PC front panel, and also can be connected with a wide range of external peripherals.

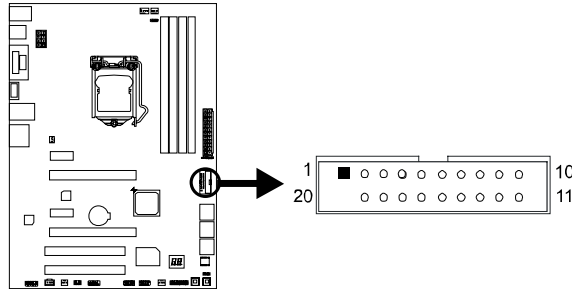

Pin	Assignment	Pin	Assignment
1	VBUS0	11	D2+
2	SSRX1-	12	D2-
3	SSRX1+	13	Ground
4	Ground	14	SSTX2+
5	SSTX1-	15	SSTX2-
6	SSTX1+	16	Ground
7	Ground	17	SSRX2+
8	D1-	18	SSRX2-
9	D1+	19	VBUS1
10	ID	20	Key

F_USB1/2: Header for USB 2.0 Ports at Front Panel

This header allows user to add additional USB ports on the PC front panel, and also can be connected with a wide range of external peripherals.

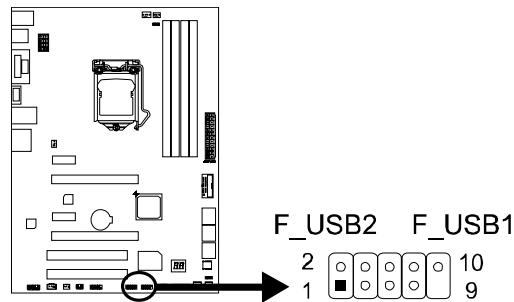

Pin	Assignment
1	+5V (fused)
2	+5V (fused)
3	USB-
4	USB-
5	USB+
6	USB+
7	Ground
8	Ground
9	Key
10	NC

F_AUDIO1: Front Panel Audio Header

This header allows user to connect the chassis-mount front panel audio I/O which supports HD and AC'97 audio standards.

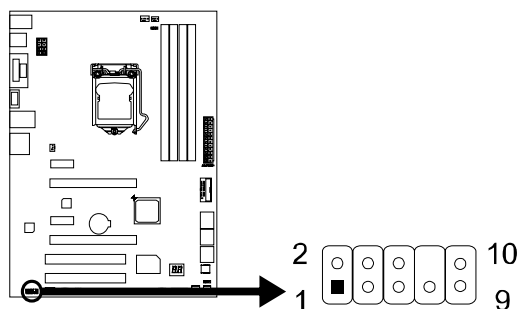

HD Audio		AC'97	
Pin	Assignment	Pin	Assignment
1	Mic Left in	1	Mic In
2	Ground	2	Ground
3	Mic Right in	3	Mic Power
4	GPIO	4	Audio Power
5	Right line in	5	RT Line Out
6	Jack Sense	6	RT Line Out
7	Front Sense	7	Reserved
8	Key	8	Key
9	Left line in	9	LFT Line Out
10	Jack Sense	10	LFT Line Out

Note1: It is recommended that you connect a high-definition front panel audio module to this connector to avail of the motherboard's high definition audio capability.
Note2: Please try to disable the "Front Panel Jack Detection" if you want to use an AC'97 front audio output cable. The function can be found via O.S. Audio Utility.

JSPDIFOUT1: Digital Audio-out Connector

The connector is for connecting the S/PDIF output bracket.

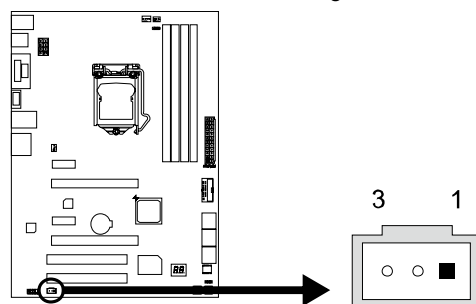

Pin	Assignment
1	+5V
2	SPDIF_OUT
3	Ground

J_COM1: Serial Port Header

The motherboard has a serial port header for connecting RS-232 Port.

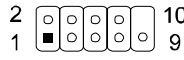
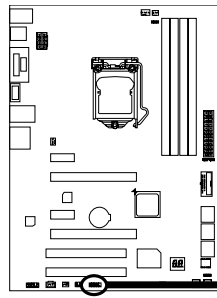

Pin	Assignment
1	Carrier detect
2	Received data
3	Transmitted data
4	Data terminal ready
5	Signal ground
6	Data set ready
7	Request to send
8	Clear to send
9	Ring indicator
10	NC

CIR1: Consumer IR Header

This header is for infrared remote control and communication.

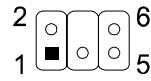
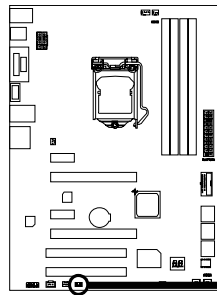

Pin	Assignment
1	IrDA serial input
2	Ground
3	Ground
4	Key
5	IrDA serial output
6	IR Power

2.8 Smart Switches & Indicators

On-Board Buttons

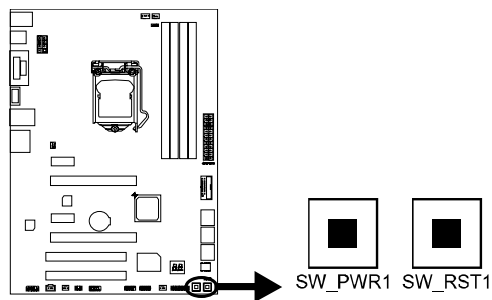

SW_PWR1:

This is an on-board Power Switch button.

SW_RST1:

This is an on-board Reset button.

BIOS POST Code/CPU Temperature Indicator

This indicator will show POST code while booting. After the booting sequence, it will show current CPU temperature in Celsius. Please refer to Chapter 4.3 for all the BIOS POST codes.

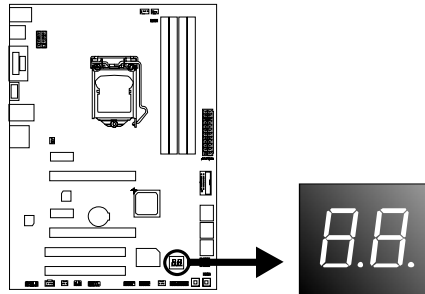

CHAPTER 3: UEFI BIOS & SOFTWARE

3.1 UEFI BIOS Setup

- The BIOS Setup program can be used to view and change the BIOS settings for the computer. The BIOS Setup program is accessed by pressing the key after the Power-On Self-Test (POST) memory test begins and before the operating system boot begins.
- For further information of setting up the UEFI BIOS, please refer to the UEFI BIOS Manual in the Setup DVD.

3.2 BIOS Update

The BIOS can be updated using either of the following utilities:

- **BIOSTAR BIOS Flasher:** Using this utility, the BIOS can be updated from a file on a hard disk, a USB drive (a flash drive or a USB hard drive), or a CD-ROM.
- **BIOSTAR BIOS Update Utility:** It enables automated updating while in the Windows environment. Using this utility, the BIOS can be updated from a file on a hard disk, a USB drive (a flash drive or a USB hard drive), or a CD-ROM, or from the file location on the Web.

BIOSTAR BIOS Flasher

Note1: This utility only allows storage device with FAT32/16 format and single partition.

Note2: Shutting down or resetting the system while updating the BIOS will lead to system boot failure.

Updating BIOS with BIOSTAR BIOS Flasher

1. Go to the website to download the latest BIOS file for the motherboard.
2. Then, copy and save the BIOS file into a USB flash (pen) drive.
3. Insert the USB pen drive that contains the BIOS file to the USB port.
4. Power on or reset the computer and then press <F12> during the POST process.

5. After entering the POST screen, the BIOS-FLASHER utility pops out. Choose [fs0] to search for the BIOS file.



6. Select the proper BIOS file, and a message asking if you are sure to flash the BIOS file. Click Yes to start updating BIOS.



7. A dialog pops out after BIOS flash is completed, asking you to restart the system. Press the [Y] key to restart system.



8. While the system boots up and the full screen logo shows up, press key to enter BIOS setup. After entering the BIOS setup, please go to the **Save & Exit**, using the **Restore Defaults** function to load Optimized Defaults, and select **Save Changes and Reset** to restart the computer. Then, the BIOS Update is completed.

BIOS Update Utility (through the Internet)

1. Installing BIOS Update Utility from the DVD Driver.
2. Please make sure the system is connected to the internet before using this function.

3. Launch BIOS Update Utility and click the **Online Update** button on the main screen.



Motherboard Manual

4. An open dialog will show up to request your agreement to start the BIOS update. Click **Yes** to start the online update procedure.

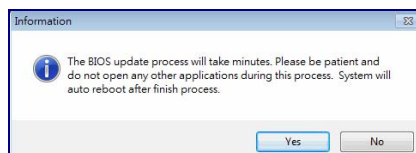

5. If there is a new BIOS version, the utility will ask you to download it. Click **Yes** to proceed.

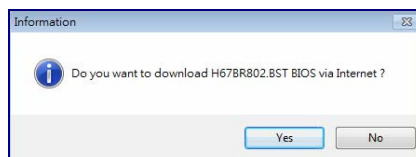

6. After the download is completed, you will be asked to program (update) the BIOS or not. Click **Yes** to proceed.

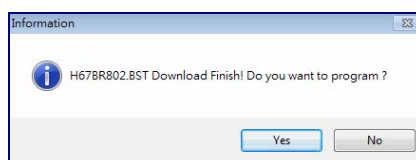

7. After the updating process is finished, you will be asked you to reboot the system. Click **OK** to reboot.

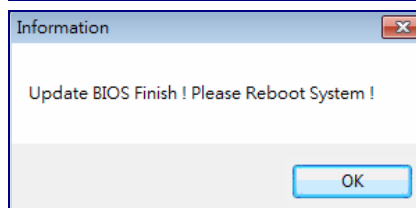

8. While the system boots up and the full screen logo shows up, press key to enter BIOS setup. After entering the BIOS setup, please go to the **Save & Exit**, using the **Restore Defaults** function to load Optimized Defaults, and select **Save Changes and Reset** to restart the computer. Then, the BIOS Update is completed.

BIOS Update Utility (through a BIOS file)

1. Installing BIOS Update Utility from the DVD Driver.
2. Download the proper BIOS from <http://www.biostar.com.tw/>

3. Launch BIOS Update Utility and click the **Update BIOS** button on the main screen.



4. A warning message will show up to request your agreement to start the BIOS update. Click **OK** to start the update procedure.

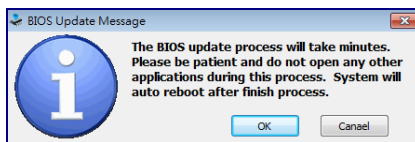

5. Choose the location for your BIOS file in the system. Please select the proper BIOS file, and then click on **Open**. It will take several minutes, please be patient.

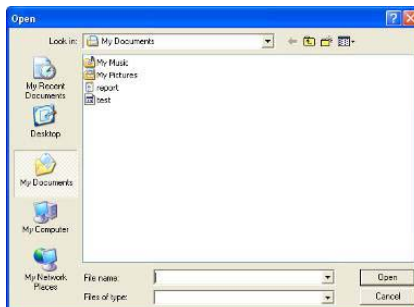

6. After the BIOS Update process is finished, click on **OK** to reboot the system.

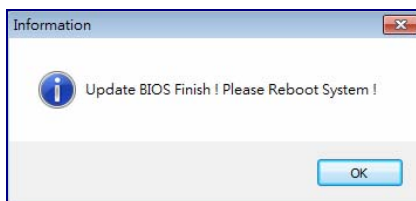

7. While the system boots up and the full screen logo shows up, press key to enter BIOS setup. After entering the BIOS setup, please go to the **Save & Exit**, using the **Restore Defaults** function to load Optimized Defaults, and select **Save Changes and Reset** to restart the computer. Then, the BIOS Update is completed.

Backup BIOS

Click the Backup BIOS button on the main screen for the backup of BIOS, and select a proper location for your backup BIOS file in the system, and click **Save**.

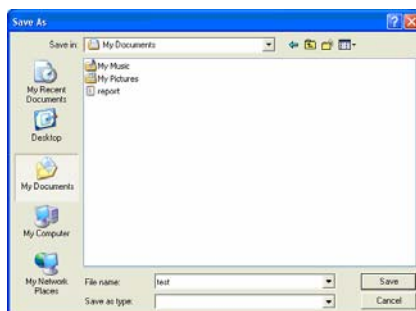

3.3 Software

Installing Software

1. Insert the Setup DVD to the optical drive. The driver installation program would appear if the Auto-run function has been enabled.
2. Select **Software Installation**, and then click on the respective software title.
3. Follow the on-screen instructions to complete the installation.

Launching Software

After the installation process is completed, you will see the software icon showing on the desktop. Double-click the icon to launch it.

Note1: All the information and content about following software are subject to be changed without notice. For better performance, the software is being continuously updated.

Note2: The information and pictures described below are for your reference only. The actual information and settings on board may be slightly different from this manual.

TOverclocker

TOverclocker presents a simple Windows-based system performance enhancement and manageability utility. It features several powerful and easy to use tools such as Overclocking for enhancing system performance, also for special enhancement on CPU and Memory. Smart-Fan management and PC health are for monitoring system status. This utility also allows you to make overclocking profiles saving unlimitedly, and pre-set OC modes are for easy OC. (The screenshots below are for reference only)



The **CPU** tab provides information on the CPU and motherboard.



The **Memory** tab provides information on the memory module(s). You can select memory module on a specific slot to see its information.

OC TWEAKER

The **OC Tweaker** tab allows you to save or load the OC setting profiles, change system frequency and voltage settings.



H/W MONITOR

The **HW Monitor** tab allows you to monitor hardware voltage, fan speed, and temperature. You can also set CPU Smart Fan function in this tab.



Note1: Not all types of CPU perform above overclock setting ideally; the difference will be based on the selected CPU model.

Note2: Overclock is an optional process, but not a “must-do” process; it is not recommended for inexperienced users. Therefore, we will not be responsible for any hardware damage which may be caused by overclocking. We also would not guarantee any overclocking performance.

Note3: Press **TOVERCLOCKER** logo, it will display information about manufacturer and software version. You can update latest version by clicking the “**Live Update**” button.

BIOScreen Utility

This utility allows you to personalize your boot logo easily. You can choose BMP as your boot logo so as to customize your computer.

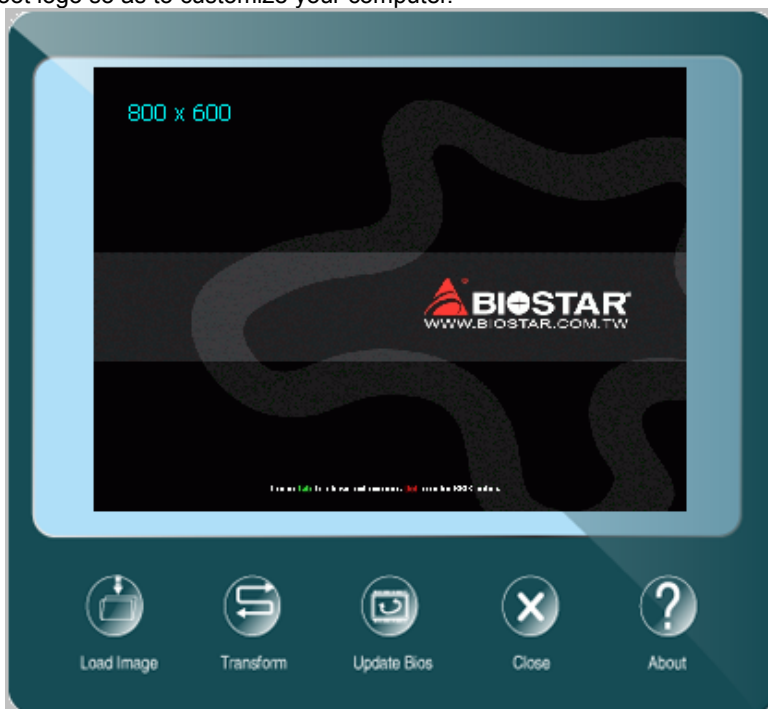

Please follow the step-by-step instructions below to update boot logo:

- Load Image : Choose the picture as the boot logo.
- Transform : Transform the picture for BIOS and preview the result.
- Update Bios : Write the picture to BIOS Memory to complete the update.

eHot-Line

eHot-Line is a convenient utility that helps you to contact with our Tech-Support system. This utility will collect the system information which is useful for analyzing the problem you may have encountered, and then send these information to our tech-support department to help you fix the problem.

Note: Before you use this utility, please set Outlook Express as your default e-mail client application program.

*represents important information that you must provide. Without this information, you may not be able to send out the mail.

This block will show the information which would be collected in the mail.

*Describe condition of your system.

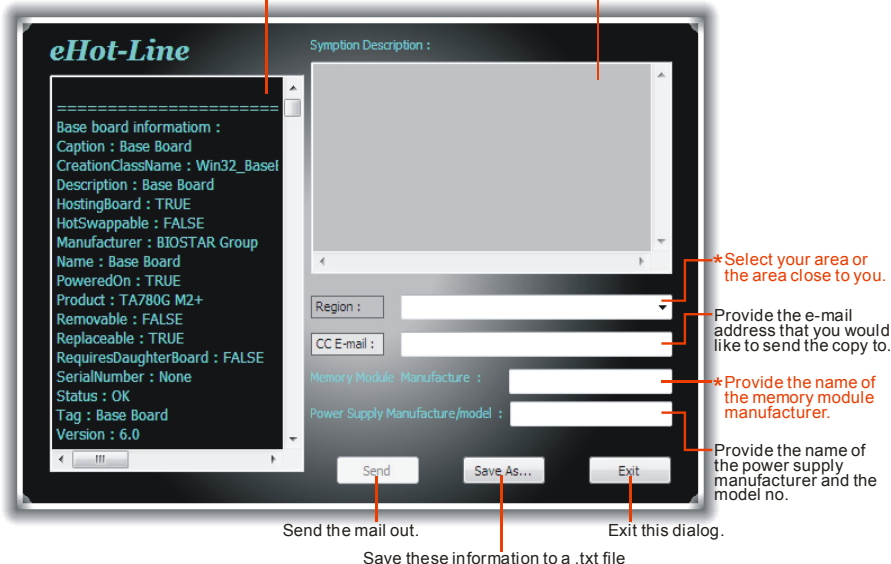

After filling up this information, click **“Send”** to send the mail out. A warning dialog would appear asking for your confirmation; click **“Send”** to confirm or **“Do Not Send”** to cancel.

If you want to save this information to a .txt file, click **“Save As...”** and then you will see a saving dialog appears asking you to enter file name.

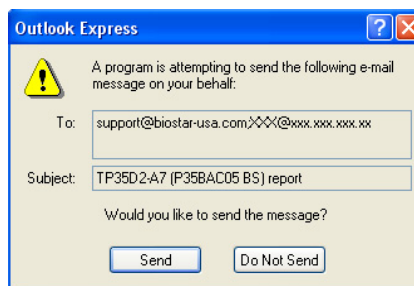

Motherboard Manual

Enter the file name and then click “**Save**”. Your system information will be saved to a .txt file.

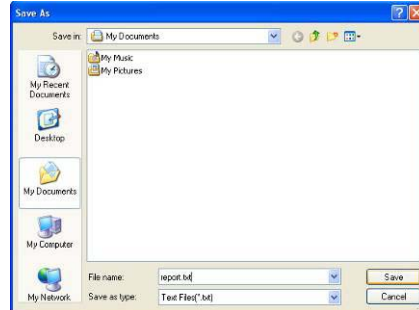

Open the saved .txt file, you will see your system information including motherboard/BIOS/CPU/video/device/OS information. This information is also concluded in the sent mail.

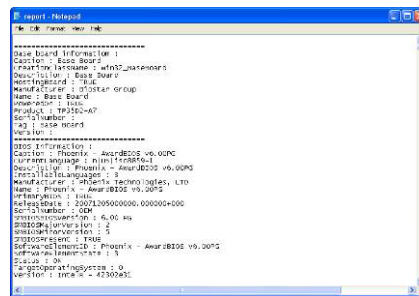

Note1: We will not share customer's data with any other third parties, so please feel free to provide your system information while using eHot-Line service.

Note2: If you are not using Outlook Express as your default e-mail client application, you may need to save the system information to a .txt file and send the file to our tech support with other e-mail application. Go to the following website <http://www.biostar.com.tw/app/en/about/contact.php> for getting our contact information.

Smart EAR 3D

Hi-Fi 3D Audio Requirements:

1. A chassis with front audio output jacks
2. An earphone or a headphone
3. Speakers
4. Windows 7 or Windows 8 operation system

Installation Guide:

1. Make sure the front audio cable of the chassis connected to the front audio header of the motherboard properly.
2. Install the Smart Ear 3D Utility from the driver DVD.
3. Connect the earphone or headphone to the front audio jack of the chassis for Smart Gain and 3D Sound Field functions.

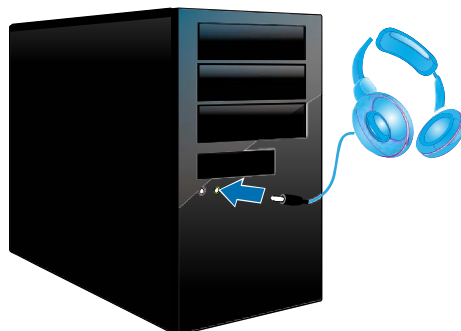

4. Connect the speakers to center, rear, side and line out ports of rear panel for Smart PREAMP function.

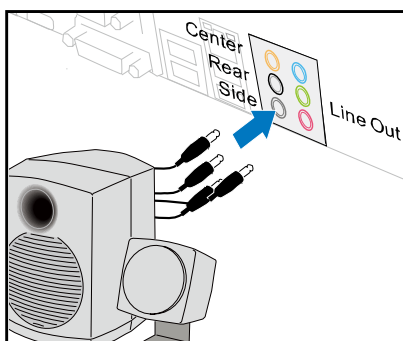

Note: If you want to use an AC'97 front audio output cable, please disable the "Front Panel Jack Detection" setting. This setting can be found via O.S. Audio Utility.

Smart EAR 3D Utility:

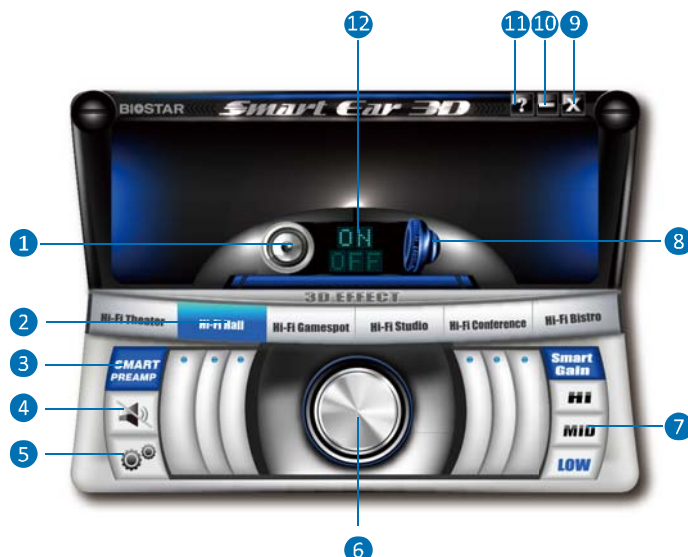

1. **Rear Panel Audio Output Indicator:** It displays a blue light when the audio output is from rear panel ports.
2. **3D Sound Field Button:** There are six sound environment options for achieving realistic listening experience. It displays a blue light when the 3D Sound Field is enabled.
3. **Smart PREAMP Button:** Click this switch to turn on or off the Smart PREAMP function.
4. **Mute Button:** To disable system sound
5. **Control Button:** It allows you to set utility preference.
6. **Volume Control Knob:** The volume can be finely adjusted by turning the knob either clockwise or anti-clockwise to increase or decrease system volume accordingly.
7. **Headphone Hi/Mid/Low Gain Switch:** It allows you to select headphone gain settings or you can let the software auto adjust headphone gain setting appropriate for your headphones. The Smart Gain function will be enabled when the 3D Sound Field Button is turned on.
8. **Front Panel Audio Output Indicator:** It displays a blue light when the audio output is from front panel port.
9. **Exit Button:** Exit the application
10. **Minimize Button:** Minimize the application window to the taskbar
11. **Information Button:** Get information of the application
12. **Smart PREAMP or Smart Gain ON/OFF Indicator:** When the Rear Panel Audio Output Indicator is lit, it shows Smart PREAMP on/off status. When the Front Panel Audio Output Indicator is lit, it shows Smart Gain on/off status.

Note1: The 3D Sound Field function is only for front panel audio output.

Note2: The Smart PREAMP function is only for rear panel audio output.

Note3: When both rear and front panels are connected with audio devices, the default audio output is from front panel.

Smart Connect Technology

Intel® Smart Connect Technology is designed to update programs by periodically waking your computer from sleep/standby mode for a short time. This function works with applications that automatically get their data from the Internet.

System Requirement:

- Intel Smart Connect Technology enabled in BIOS Setup
- Set the “ACPI Sleep State” to S3 in BIOS Setup.
- Windows 7 and Windows 8
- Normal internet connection

Configuring Intel Smart Connect Technology

Step 1: After installing the operating system and motherboard drivers, install the Intel Smart Connect Technology application. Restart your computer when completed.

Step 2: Click on start menu and input "regedit" in the search bar. Press enter to open the registry editor. Look for the following directory in the registry editor:

Computer\HKEY_LOCAL_MACHINE\SOFTWARE\Intel\Intel Smart Connect Technology

Right-click on *Intel Smart Connect Technology* and select *New > Key*. Type “OEM”.

Note: Intel Smart Connect Technology is for S3 mode only. During the updating process, the monitor will not light up and no sound will be output from the speaker.

Step 3: As shown in the screenshot below, right-click on OEM, select *New > Multi-String Value*, and type “WhiteList”. Double-click *WhiteList* and type the application name to be added in *Edit Multi-String*. For example, to add Microsoft Live Mail, type “wmail.exe”. Restart your computer when completed.

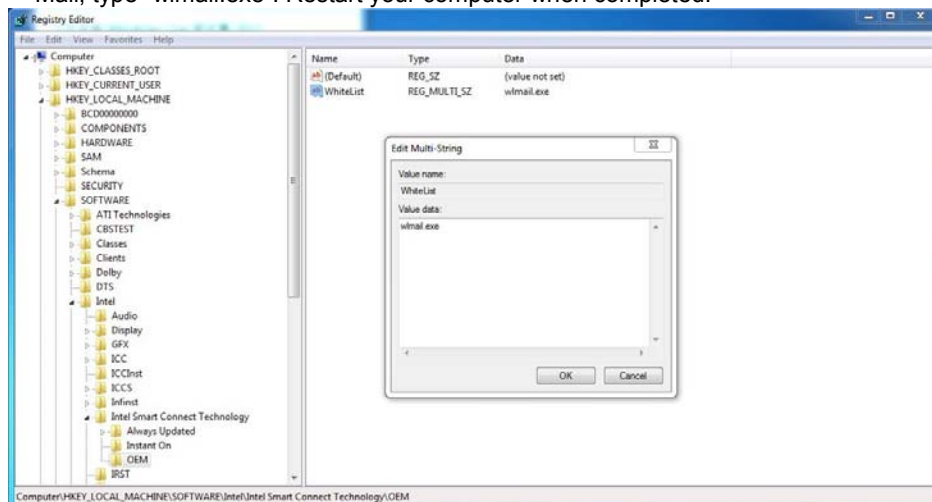

Step 4: After completing the steps above, go to `Start\All Programs\Intel` and launch Intel(R) Smart Connect Technology.

Basic and advanced settings

Basic Tab

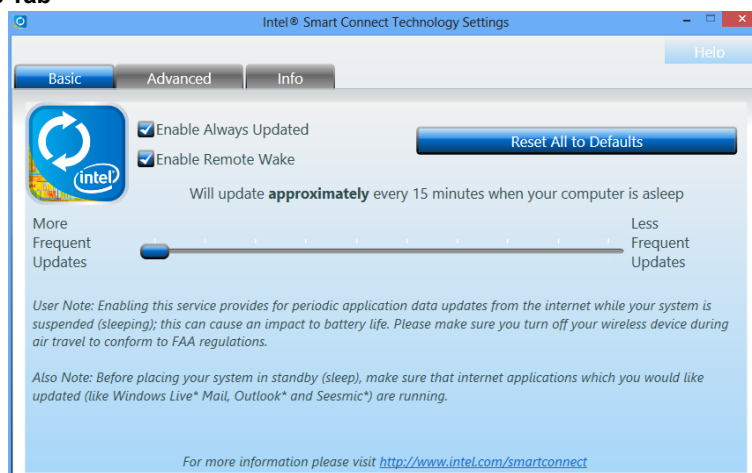

Update Frequency slider: This slider bar sets the amount of time the feature waits to wake your computer and update your applications. Move the slider in the user interface to change the frequency. The slider bar can be set to wake and update your computer from every 15 to 60 minutes. The longer the time between updates the less power the feature consumes.

Reset All to Defaults button: This button is designed to reset Intel® Smart Connect Technology back to the original factory setting for wake frequency.

Advanced Tab

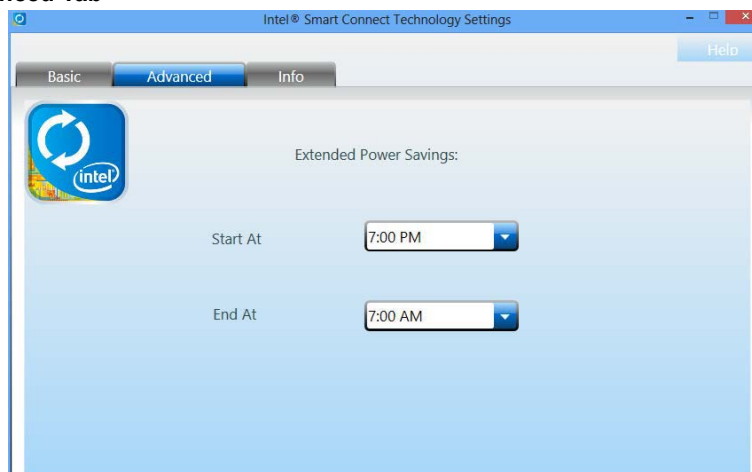

Extended Power Savings: You can set a time for Intel Smart Connect Technology to work in Extended Power Savings mode. This night time mode updates your computer every two hours, saving power for the times you are not using your computer.

Rapid Start Technology

Intel® Rapid Start technology enables your system to get up and running faster from even the deepest sleep, saving time and power consumption. Feel secure knowing that your system will still resume to working conditions in the event of unexpected power loss while in sleep mode.

System Requirement:

- An Intel® SATA SSD (SATA Gen2 or Gen3. Preferably Gen3, and 80 GB or larger)
- Windows 7 and Windows 8

Note1: Please visit below webpage for more details about operating systems supporting http://www.intel.com/p/en_US/support

Installing Intel® RST:

Step 1: BIOS Setting

- 1-1 Go to [Advanced Menu] > [ACPI Settings], and set [ACPI Sleep State] to S3 (Suspend to RAM)
- 1-2 Go to [Advanced Menu] > [SATA Configuration], and set [SATA Mode Selection] to AHCI
- 1-3 Go to [Advanced Menu] and set [Intel(R) Rapid Start Technology] to Enabled
- 1-4 Save your changes, and then exit the BIOS Setup.

Step 2: Operating System Installation

Step 3: Installing Intel® Rapid Start Application

- 3-1 Insert the setup Driver DVD into your optical drive. Click “Intel Rapid Start Technology” to launch the program.
- 3-2 Below window will pop-out, then click “Create Disk” to start disk partition. After disk partition finished, please click “OK” then system will reboot automatically.

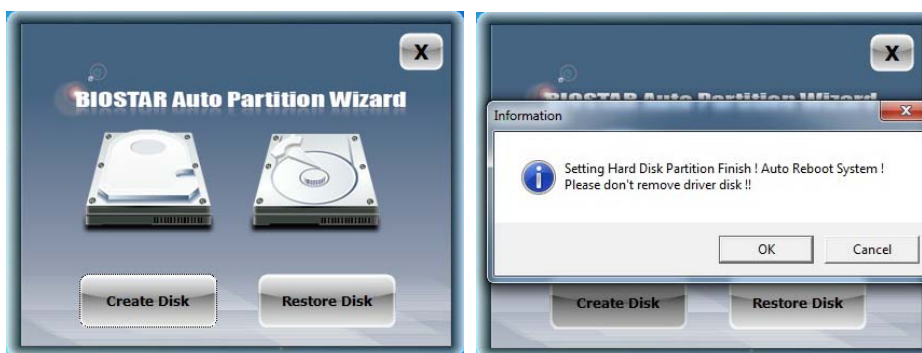

Motherboard Manual

3-3 After rebooting, the system will setup Intel® Rapid Start Technology automatically. We recommend you restart the system after this installation is complete,



Step 4: Configuring Intel® Rapid Start Application

Launch the Intel® Rapid Start Technology Manager application from [Start] > [All Programs] > [Intel] or click the icon  in the notification area.

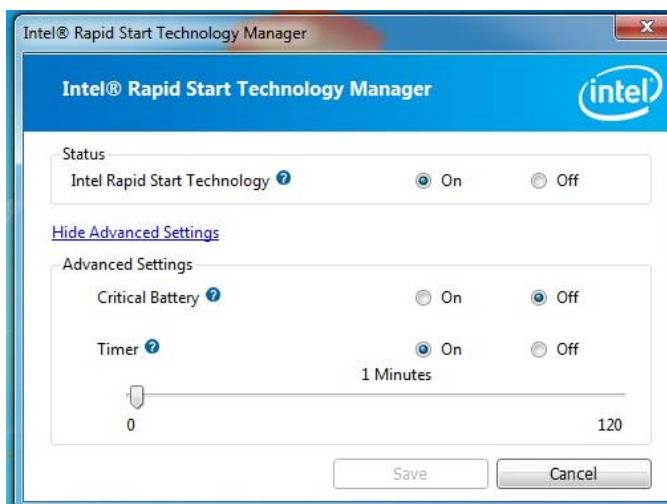

Intel® Small Business Advantage

Intel Small Business Advantage (Intel SBA) provides an out-of-the-box hardware-based security and productivity suite designed for the small business user.

Software Monitor

Software Monitor helps keep critical security software running by monitoring it at the hardware level and alerting the business if there has been an attack. The Software Monitor also maintains an event log that shows status information and any errors generated, so businesses can know what happened.

Data Backup and Restore

Data Backup and Restore provides reliable after-hours backup of critical data using the local maintenance timer to power on the computer. Data can be backed up to a designated location.

USB Blocker

The optional USB Blocker lets businesses control access to their infrastructure, preventing unauthorized USB devices or file imports or exports on company computers.

PC Health Center

PC Health Center can schedule and do PC maintenance tasks after hours, without interrupting employee work time. Tasks such as updating the operating system, deleting temporary internet files, and running disk defragmentation can be done at night. PC Health Center works even if the computer is powered-down, as long as it is plugged in.

Energy Saver

With the optional Energy Saver, businesses can save energy by scheduling PCs to power-down at the end of the day and turn on before the work day begins - ready for employees as they arrive in the morning.

Supported Operating Systems:

Windows 7 and Windows 8

Note1: Please visit below webpage for more details about operating systems supporting http://www.intel.com/p/en_US/support

Note2: The Intel® Small Business Advantage is only supported by H87 & B85 chipsets.

Installing Intel SBA

This procedure describes how to install Intel SBA.

1. Logon to the computer with a user that has administrator privileges.
2. Copy the Setup.exe file to the computer.
3. Double-click Setup.exe.

The Welcome to the Setup Program window opens.

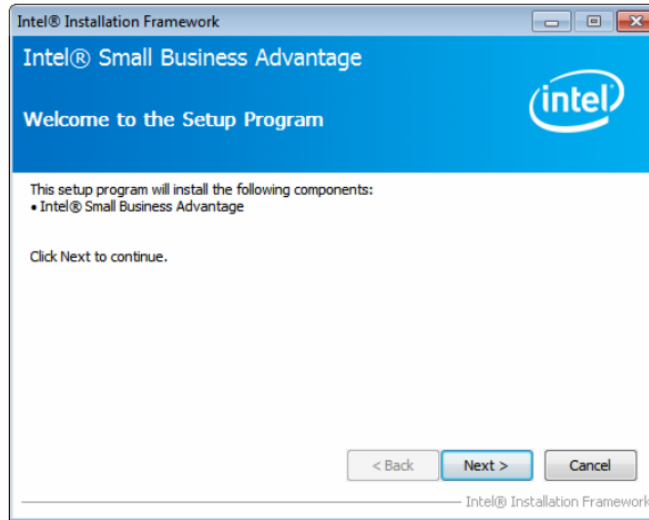

4. Click Next. The installer starts the installation and the Setup Progress window opens showing the progress of the installation. When installation is complete, the installer starts the Intel SBA service and the Next button is enabled.

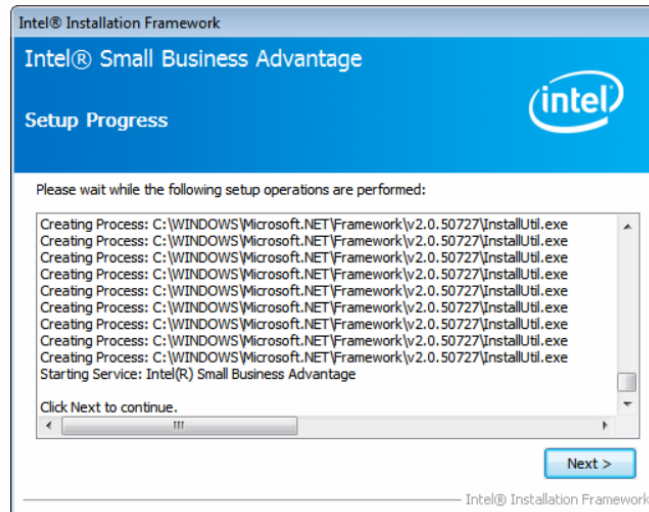

5. Click Next. The Setup Is Complete window opens.
6. Click Finish. The installer closes.

Green Power II Utility

BIOSTAR G.P.U II (Green Power Utility) is a new function. The utility enhances energy efficiency by disabling extra phases while CPU is on light loading; it features 4+1 power phases, current power saving, and total power saving. This tool integrates a friendly GUI to monitor your CPU Usage, CPU Watt, and CPU Temperature. Moreover, it optimizes power saving and best power efficiency on your system. (The illustration below is for reference only)

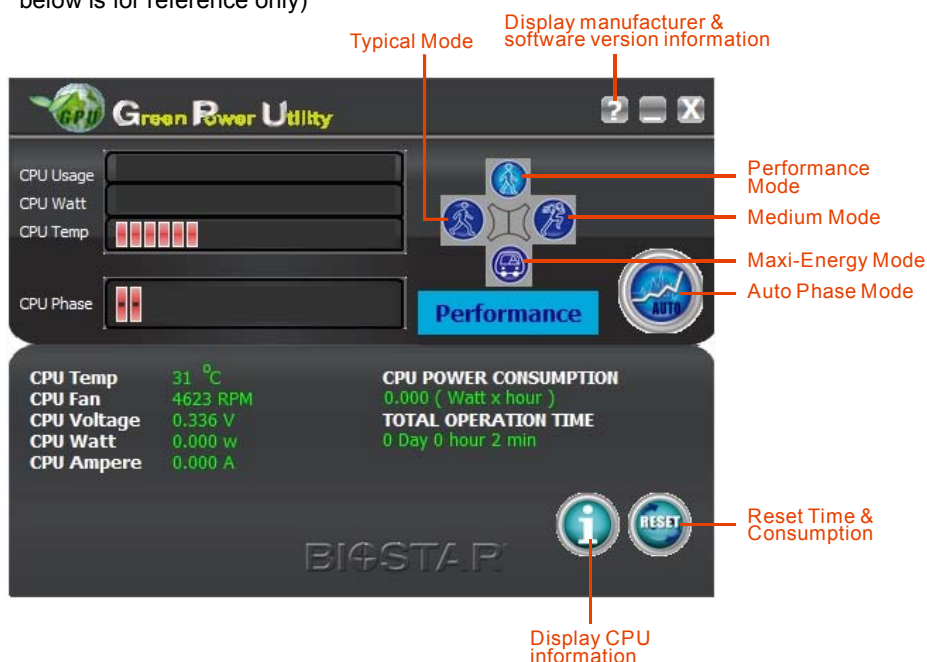

G.P.U Mode Setting:

This utility provides five modes, upon your requirements, to improve system performance or to save power consumption.

Note: Even if the modes saving more power consumption are chosen, the system still can keep excellent performance.

- **Auto Phase Mode:** System switches the mode automatically according to current system loading condition.
- **Performance Mode:** This is the mode saving power consumption most. Least energy will be used in the system.
- **Typical Mode:** Compared with that in Performance Mode, energy consumption in this mode is a little bit more.
- **Medium Mode:** The standard system power saving mode.
- **Maxi-Energy Mode:** The best system performance mode.

CHAPTER 4: USEFUL HELP

4.1 Driver Installation

After you installed your operating system, please insert the Fully Setup Driver DVD into your optical drive and install the driver for better system performance.

You will see the following window after you insert the DVD



The setup guide will auto detect your motherboard and operating system.

A. Driver Installation

To install the driver, please click on the Driver icon. The setup guide will list the compatible driver for your motherboard and operating system. Click on each device driver to launch the installation program.

B. Software Installation

To install the software, please click on the Software icon. The setup guide will list the software available for your system, click on each software title to launch the installation program.

C. Manual

Aside from the paperback manual, we also provide manual in the Driver DVD. Click on the Manual icon to browse for available manuals.

Note1: If this window didn't show up after you insert the Driver DVD, please use file browser to locate and execute the file SETUP.EXE under your optical drive.

Note2: You will need Acrobat Reader to open the manual file. Please download the latest version of Acrobat Reader software from <http://get.adobe.com/reader/>

4.2 AMI BIOS Beep Code

Boot Block Beep Codes

Number of Beeps	Description
Continuing	Memory sizing error or Memory module not found

POST BIOS Beep Codes

Number of Beeps	Description
1	Success booting.
8	Display memory error (system video adapter)

4.3 AMI BIOS Post Code

Code	Description
10	PEI Core is started
11	Pre-memory CPU initialization is started
15	Pre-memory North Bridge initialization is started
19	Pre-memory South Bridge initialization is started
2B	Memory initialization. Serial Presence Detect (SPD) data reading
2C	Memory initialization. Memory presence detection
2D	Memory initialization. Programming memory timing information
2E	Memory initialization. Configuring memory
2F	Memory initialization (other).
31	Memory Installed
32	CPU post-memory initialization is started
33	CPU post-memory initialization. Cache initialization
34	CPU post-memory initialization. Application Processor(s) (AP) initialization
35	CPU post-memory initialization. Boot Strap Processor (BSP) selection
36	CPU post-memory initialization. System Management Mode (SMM) initialization
37	Post-Memory North Bridge initialization is started
3B	Post-Memory North Bridge initialization (North Bridge module specific)
4F	DXE IPL is started
60	DXE Core is started
F0	Recovery condition triggered by firmware (Auto recovery)
F1	Recovery condition triggered by user (Forced recovery)
F2	Recovery process started
F3	Recovery firmware image is found
F4	Recovery firmware image is loaded
E0	S3 Resume is started (S3 Resume PPI is called by the DXE IPL)
E1	S3 Boot Script execution
E2	Video repost
E3	OS S3 wake vector call
60	DXE Core is started
61	NVRAM initialization
62	Installation of the South Bridge Runtime Services
63	CPU DXE initialization is started
68	PCI host bridge initialization
69	North Bridge DXE initialization is started
6A	North Bridge DXE SMM initialization is started
70	South Bridge DXE initialization is started

Motherboard Manual

Code	Description
71	South Bridge DXE SMM initialization is started
72	South Bridge devices initialization
78	South Bridge DXE Initialization (South Bridge module specific)
79	ACPI module initialization
90	Boot Device Selection (BDS) phase is started
91	Driver connecting is started
92	PCI Bus initialization is started
93	PCI Bus Hot Plug Controller Initialization
94	PCI Bus Enumeration
95	PCI Bus Request Resources
96	PCI Bus Assign Resources
97	Console Output devices connect
98	Console input devices connect
99	Super IO Initialization
9A	USB initialization is started
9B	USB Reset
9C	USB Detect
9D	USB Enable
A0	IDE initialization is started
A1	IDE Reset
A2	IDE Detect
A3	IDE Enable
A4	SCSI initialization is started
A5	SCSI Reset
A6	SCSI Detect
A7	SCSI Enable
A8	Setup Verifying Password
A9	Start of Setup
AB	Setup Input Wait
AD	Ready To Boot event
AE	Legacy Boot event
AF	Exit Boot Services event
B0	Runtime Set Virtual Address MAP Begin
B1	Runtime Set Virtual Address MAP End
B2	Legacy Option ROM Initialization
B3	System Reset
B4	USB hot plug
B5	PCI bus hot plug
B6	Clean-up of NVRAM
B7	Configuration Reset (reset of NVRAM settings)

Note: If the post code is not listed on above table, please feel free contact our technical support.

4.4 Troubleshooting

Probable	Solution
<ol style="list-style-type: none"> 1. There is no power in the system. Power LED does not shine; the fan of the power supply does not work 2. Indicator light on keyboard does not shine. 	<ol style="list-style-type: none"> 1. Make sure power cable is securely plugged in. 2. Replace cable. 3. Contact technical support.
System is inoperative. Keyboard lights are on, power indicator lights are lit, and hard drives are running.	Using even pressure on both ends of the DIMM, press down firmly until the module snaps into place.
System does not boot from a hard disk drive, but can be booted from optical drive.	<ol style="list-style-type: none"> 1. Check cable running from disk to disk controller board. Make sure both ends are securely plugged in; check the drive type in the standard CMOS setup. 2. Backing up the hard drive is extremely important. All hard disks are capable of breaking down at any time.
System only boots from an optical drive. Hard disks can be read, applications can be used, but system fails to boot from a hard disk.	<ol style="list-style-type: none"> 1. Back up data and applications files. 2. Reformat the hard drive. Re-install applications and data using backup disks.
Screen message shows "Invalid Configuration" or "CMOS Failure."	Review system's equipment. Make sure correct information is in setup.
System cannot boot after user installs a second hard drive.	<ol style="list-style-type: none"> 1. Set master/slave jumpers correctly. 2. Run SETUP program and select correct drive types. Call the drive manufacturers for compatibility with other drives.

CPU Overheated

If the system shutdown automatically after power on system for seconds, that means the CPU protection function has been activated.

When the CPU is over heated, the motherboard will shutdown automatically to avoid a damage of the CPU, and the system may not power on again.

In this case, please double check:

1. The CPU cooler surface is placed evenly with the CPU surface.
2. CPU fan is rotated normally.
3. CPU fan speed is fulfilling with the CPU speed.

After confirmed, please follow steps below to relief the CPU protection function.

1. Remove the power cord from power supply for seconds.
2. Wait for seconds.
3. Plug in the power cord and boot up the system.

Or you can:

1. Clear the CMOS data.
2. Wait for seconds.
3. Power on the system again.

4.5 RAID Functions

RAID Definitions

RAID 0:

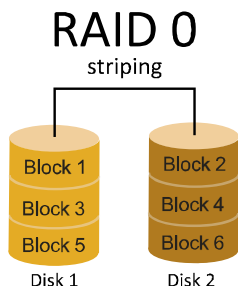

In a RAID 0 system data are split up in blocks that get written across all the drives in the array. By using multiple disks (at least 2) at the same time, this offers superior I/O performance. This performance can be enhanced further by using multiple controllers, ideally one controller per disk.

Features and Benefits

- **Drives:** Minimum 2, and maximum is up to 6 or 8. Depending on the platform.
- **Uses:** Intended for non-critical data requiring high data throughput, or any environment that does not require fault tolerance.
- **Benefits:** provides increased data throughput, especially for large files. No capacity loss penalty for parity.
- **Drawbacks:** Does not deliver any fault tolerance. If any drive in the array fails, all data is lost.
- **Fault Tolerance:** No.
- **Total Capacity:** (Minimal. HDD Capacity) x (Connected HDDs Amount)

RAID 1:

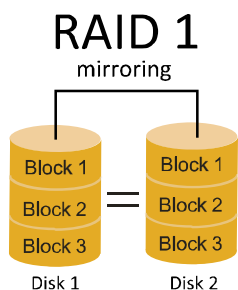

Data are stored twice by writing them to both the data disk(or set of data disks) and a mirror disk (or set of disks). If a disk fails, the controller uses either the data drive or the mirror drive for data recovery and continues operation. You need at least 2 disks for a RAID 1 array.

Features and Benefits

- **Drives:** Minimum 2, and maximum is 2.
- **Uses:** RAID 1 is ideal for small databases or any other application that requires fault tolerance and minimal capacity.
- **Benefits:** Provides 100% data redundancy. Should one drive fail, the controller switches to the other drive.
- **Drawbacks:** Requires 2 drives for the storage space of one drive. Performance is impaired during drive rebuilds.
- **Fault Tolerance:** Yes.

RAID 10:

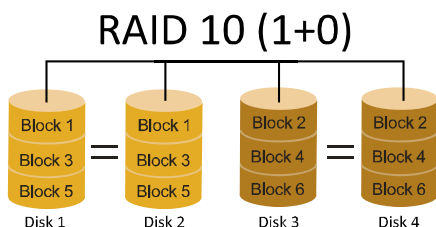

RAID 10 combines the advantages (and disadvantages) of RAID 0 and RAID 1 in one single system. It provides security by mirroring all data on a secondary set of disks (disk 3 and 4 in the drawing below) while using striping across each set of disks to speed up data transfers.

Features and Benefits

- **Drives:** Minimum 4, and maximum is 6 or 8, depending on the platform.
- **Benefits:** Optimizes for both fault tolerance and performance, allowing for automatic redundancy. May be simultaneously used with other RAID levels in an array, and allows for spare disks.
- **Drawbacks:** Requires twice the available disk space for data redundancy, the same as RAID level 1.
- **Fault Tolerance:** Yes.

RAID 5:

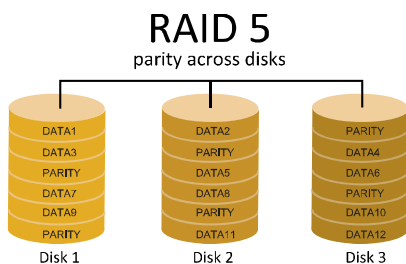

A RAID 5 array can withstand a single disk failure without losing data or access to data. Although RAID 5 can be achieved in software, a hardware controller is recommended. Often extra cache memory is used on these controllers to improve the write performance.

Features and Benefits

- **Drives:** Minimum 3.
- **Uses:** RAID 5 is recommended for transaction processing and general purpose service.
- **Benefits:** An ideal combination of good performance, good fault tolerance, and high capacity and storage efficiency.
- **Drawbacks:** Individual block data transfer rate same as a single disk. Write performance can be CPU intensive.
- **Fault Tolerance:** Yes.

Note1: The RAID 0,1,10 and 5 functions are only supported by Z87 & H87 chipsets.
Note2: For more details settings about Intel® Rapid Storage Technology (Intel® RST), please visit http://www.intel.com/p/en_US/support/highlights/chpsts/ims

APPENDIX: Specifications in Other Languages**Arabic**

المواصفات	
Intel® Core i7 / i5 / i3 / Pentium / Celeron المأخذ 1150 لمعالج ايه إم دي الحد الأقصى للطاقة الحرارية في تصميم المعالج (thermal design power – TDP): 95 واط. * يرجى الرجوع إلى الموقع www.biostar.com.tw لقائمة دعم المعالج CPU.	قاعدة وحدة المعالجة المركزية
INTEL® B85 (Hi-Fi B85W 3D) INTEL® Z87 (Hi-Fi Z87W 3D) INTEL® H87 (Hi-Fi H87W 3D)	مجموعة الشرائح
تدعم قناة مزدوجة دي. دي. ار. DDR3 1066/ 1333/ 1600 تدعم قناة مزدوجة دي. دي. ار. DDR3 1800(OC) / 1866(OC) / 2133(OC) / 2200(OC) / 2400(OC) (Hi-Fi Z87W 3D) 2600(OC) / 2667(OC) / 2800(OC) 4x دي. دي. ار. DDR3 فتحات الذاكرة المزدوجة DIMM، تتحمل كحد أقصى 32 جيجابايت ذاكرة كل فتحة مزدوجة DIMM تتحمل دون 512 ECC ميجا بايت 8/4/2/1 جيجابايت دي. دي. ار. DDR3 * يرجى الرجوع إلى الموقع www.biostar.com.tw لقائمة دعم الذاكرة.	الذاكرة
INTEL® B85 INTEL® Z87 & H87 وصلة 4x ساتا SATA 6 جيجا بايت / الثانية وصلة 2x ساتا SATA 3 جيجا بايت / الثانية تتحمّل رايد AHCI	التخزين
ريالتيك رت ل REALTEK RTL 8111G 1000 / 100 / 10 ميجابايت / الثانية ، تحديد تلقائي ، النصف / القدرة القصوى المزدوجة	شبكة محلية LAN
ALC892 7.1 قنوات عالية الدقة Biostar Hi-Fi 3D	الترميز الصوتي
منافذ 4 x ناقل متسلسل عام USB 3.0 (2 في المداخل والمخارج الخلفية و 2 من خلال الموزع الداخلي) منافذ 8 x ناقل متسلسل عام USB 2.0 (4 في المداخل والمخارج الخلفية و 4 من خلال الموزع الداخلي)	ناقل متسلسل عام USB
2 x فتحة منفذ الملحقات الإضافية PCI 2 x فتحة منفذ الملحقات الإضافية PCIe 1 x 2.0 1 x فتحة منفذ الملحقات الإضافية PCIe (x4) 16 x 2.0 1 x فتحة منفذ الملحقات الإضافية PCIe (x16) 16 x 3.0	فتحات التوسع
1 x 2 PS/2 لوحة المفاتيح للكمبيوتر/الفايرة فتحة توصيل عدد 1 x HDMI وسيط متعدد العالي الوضوح فتحة توصيل عدد 1 x منظومة العرض المرني VGA فتحة توصيل عدد 1 x واجهة مرئية رقمية DVI فتحة لتوصيل عدد 1 x الشبكة المحلية LAN فتحة توصيل عدد 4 x ناقل متسلسل عام USB 2.0 فتحة توصيل عدد 2 x ناقل متسلسل عام USB 3.0 فتحة توصيل عدد 6 x جاك للصوت	المداخل والمخارج الخلفية

Hi-Fi Z87W 3D/Hi-Fi H87W 3D/Hi-Fi B85W 3D

المواصفات		
<p style="text-align: center;">Hi-Fi B85W 3D</p> <p>وصلة 4 x SATA 6 جيجابايت / الثانية</p> <p>وصلة 2 x SATA 3 جيجابايت / الثانية</p> <p>موزع 2 x ناقل متسلسل عام USB 2.0 (كل موزع يتحمل فتحتين ناقل متسلسل عام USB 2.0)</p> <p>موزع 1 x ناقل متسلسل عام USB 3.0 (كل موزع يتحمل فتحتين ناقل متسلسل عام USB 3.0)</p> <p>وصلة للطاقة 1 x 8 دبابيس</p> <p>وصلة للطاقة 1 x 24 دبابيس</p> <p>وصلة 1 x مروحة تبريد وحدة المعالجة المركزية</p> <p>وصلة 4 x مروحة تبريد المنظومة</p> <p>موزع 1 x اللوحة الأمامية</p> <p>موزع 1 x الصوت الأمامي</p> <p>موزع 1 x سيموس مباشر</p> <p>موزع 1 x مستهلك IR</p> <p>موزع 1 x فتحة تسلسلية</p> <p>وصلة 1 x خارجية S/PDIF سوني فيليبس الواجهة الرقمية</p>	<p style="text-align: center;">Hi-Fi Z87W 3D & Hi-Fi H87W 3D</p> <p>وصلة 6 x SATA 6 جيجابايت / الثانية</p> <p>موزع 2 x ناقل متسلسل عام USB 2.0 (كل موزع يتحمل فتحتين ناقل متسلسل عام USB 2.0)</p> <p>موزع 1 x ناقل متسلسل عام USB 3.0 (كل موزع يتحمل فتحتين ناقل متسلسل عام USB 3.0)</p> <p>وصلة للطاقة 1 x 8 دبابيس</p> <p>وصلة للطاقة 1 x 24 دبابيس</p> <p>وصلة 1 x مروحة تبريد وحدة المعالجة المركزية</p> <p>وصلة 4 x مروحة تبريد المنظومة</p> <p>موزع 1 x اللوحة الأمامية</p> <p>موزع 1 x الصوت الأمامي</p> <p>موزع 1 x سيموس مباشر</p> <p>موزع 1 x مستهلك IR</p> <p>موزع 1 x فتحة تسلسلية</p> <p>وصلة 1 x خارجية S/PDIF سوني فيليبس الواجهة الرقمية</p>	<p>المدخل والمخارج الداخلية</p>
عامل الشكل 305 x 220 مم ATX		عامل الشكل
ويندوز 7 / ويندوز 8		أنظمة التشغيل المدعومة
بيوستار BIOSTAR تحتفظ بحق إضافة أو إزالة الدعم لأي نظام تشغيل مع أو بدون أنظار.		

French

Spécifications	
Support Unité Centrale	Socket 1150 Processeurs Intel® Core i7 / i5 / i3 / Pentium / Celeron Enveloppe thermique Unité Centrale maximum : 95Watt * Veuillez vous reporter à www.biostar.com.tw pour la liste des supports modèles d'Unité Centrale.
Jeu de puces	INTEL® Z87 (Hi-Fi Z87W 3D) INTEL® B85 (Hi-Fi B85W 3D) INTEL® H87 (Hi-Fi H87W 3D)
Mémoire	Supporte mémoire DDR3 double canal 1066/ 1333/ 1600 Supporte mémoire DDR3 double canal 1800(OC) / 1866(OC) / 2133(OC) / 2200(OC) / 2400(OC) / 2600(OC) / 2667(OC) / 2800(OC) (Hi-Fi Z87W 3D) Banc de mémoire 4 x DDR3 DIMM, Supporte max. jusqu'à une mémoire de 32 GB Chaque module DIMM supporte module DDR3 non-ECC 512MB/ 1/ 2/ 4/ 8 GB * Veuillez vous reporter à www.biostar.com.tw pour la liste des soutien de la mémoire.
Stockage	INTEL® Z87 & H87: INTEL® B85: Connecteur 6 x SATA 6Gb/s Connecteur 4 x SATA 6Gb/s Supporte système RAID 0,1,10,5, SRT & AHCI Connecteur 2 x SATA 3Gb/s Supporte système AHCI
Réseau local	Realtek RTL 8111G 10/ 100/ 1000 Mb/s auto négociation, capacité bidirectionnelle à l'alternat / bidirectionnelle simultanée
Codec audio	ALC892 Canaux 7.1, écoute audio de haute définition, Biostar Hi-Fi 3D
USB	Port 4x USB 3.0 (2 sur les I/O arrières et 2 en interne) Port 8x USB 2.0 (4 sur les I/O arrières et 4 en interne)
Connecteur d'extension	2x PCI Fente 2x PCIe 2.0 x1 Fente 1x PCIe 2.0 x16 Fente (x4) 1x PCIe 3.0 x16 Fente (x16)
I/O arrières	1x PS/2 Clavier/ Souris 1x Port HDMI 1x Port VGA 1x Port DVI 1x port LAN 4x Port USB 2.0 2x Port USB 3.0 6x entrées audio

Hi-Fi Z87W 3D/Hi-Fi H87W 3D/Hi-Fi B85W 3D

Spécifications			
I/O en interne	<table style="width: 100%; border-collapse: collapse;"> <tr> <td style="width: 50%; vertical-align: top;"> Hi-Fi Z87W 3D & Hi-Fi H87W 3D 6x Connecteur SATA 6.0Gb/s 2x embases USB 2.0 (chaque embase supporte 2 Ports USB 2.0) 1x embase USB 3.0 (chaque embase supporte 2 Ports USB 3.0) 1x 8-Broche de carte 1x 24-Broche de carte 1x Connecteur ventilateur unité centrale 4x Connecteur ventilateur système 1x Fiche panneau avant 1x Fiche audio avant 1x Fiche mémoire CMOS vide 1x Fiche Registre d'état Consommateur 1x Embase port série 1x Connecteur sortie S/PDIF </td> <td style="width: 50%; vertical-align: top;"> Hi-Fi B85W 3D 4x Connecteur SATA 6.0Gb/s 2x Connecteur SATA 3.0Gb/s 2x embases USB 2.0 (chaque embase supporte 2 Ports USB 2.0) 1x embase USB 3.0 (chaque embase supporte 2 Ports USB 3.0) 1x 8-Broche de carte 1x 24-Broche de carte 1x Connecteur ventilateur unité centrale 4x Connecteur ventilateur système 1x Fiche panneau avant 1x Fiche audio avant 1x Fiche mémoire CMOS vide 1x Fiche Registre d'état Consommateur 1x Embase port série 1x Connecteur sortie S/PDIF </td> </tr> </table>	Hi-Fi Z87W 3D & Hi-Fi H87W 3D 6x Connecteur SATA 6.0Gb/s 2x embases USB 2.0 (chaque embase supporte 2 Ports USB 2.0) 1x embase USB 3.0 (chaque embase supporte 2 Ports USB 3.0) 1x 8-Broche de carte 1x 24-Broche de carte 1x Connecteur ventilateur unité centrale 4x Connecteur ventilateur système 1x Fiche panneau avant 1x Fiche audio avant 1x Fiche mémoire CMOS vide 1x Fiche Registre d'état Consommateur 1x Embase port série 1x Connecteur sortie S/PDIF	Hi-Fi B85W 3D 4x Connecteur SATA 6.0Gb/s 2x Connecteur SATA 3.0Gb/s 2x embases USB 2.0 (chaque embase supporte 2 Ports USB 2.0) 1x embase USB 3.0 (chaque embase supporte 2 Ports USB 3.0) 1x 8-Broche de carte 1x 24-Broche de carte 1x Connecteur ventilateur unité centrale 4x Connecteur ventilateur système 1x Fiche panneau avant 1x Fiche audio avant 1x Fiche mémoire CMOS vide 1x Fiche Registre d'état Consommateur 1x Embase port série 1x Connecteur sortie S/PDIF
Hi-Fi Z87W 3D & Hi-Fi H87W 3D 6x Connecteur SATA 6.0Gb/s 2x embases USB 2.0 (chaque embase supporte 2 Ports USB 2.0) 1x embase USB 3.0 (chaque embase supporte 2 Ports USB 3.0) 1x 8-Broche de carte 1x 24-Broche de carte 1x Connecteur ventilateur unité centrale 4x Connecteur ventilateur système 1x Fiche panneau avant 1x Fiche audio avant 1x Fiche mémoire CMOS vide 1x Fiche Registre d'état Consommateur 1x Embase port série 1x Connecteur sortie S/PDIF	Hi-Fi B85W 3D 4x Connecteur SATA 6.0Gb/s 2x Connecteur SATA 3.0Gb/s 2x embases USB 2.0 (chaque embase supporte 2 Ports USB 2.0) 1x embase USB 3.0 (chaque embase supporte 2 Ports USB 3.0) 1x 8-Broche de carte 1x 24-Broche de carte 1x Connecteur ventilateur unité centrale 4x Connecteur ventilateur système 1x Fiche panneau avant 1x Fiche audio avant 1x Fiche mémoire CMOS vide 1x Fiche Registre d'état Consommateur 1x Embase port série 1x Connecteur sortie S/PDIF		
Facteur d'encombrement	Facteur d'encombrement ATX, 305 mm x 220 mm		
Support SE	Windows 7 / 8 Biostar se réserve le droit d'ajouter ou d'enlever le support pour toute SE avec ou sans préavis.		

German

Spezifikationen	
CPU-Unterstützung	Anschluss-1150 für Intel® Core i7 / i5 / i3 / Pentium / Celeron Prozessor Maximale CPU TDP (Thermal Design Power): 95 Watt * Bitte konsultieren Sie www.biostar.com.tw für CPU-Unterstützungsliste
Chipset	INTEL® Z87 (Hi-Fi Z87W 3D) INTEL® B85 (Hi-Fi B85W 3D) INTEL® H87 (Hi-Fi H87W 3D)
Festplattenspeicher	Unterstützt zweikanaliges DDR3 1066/ 1333/ 1600 Unterstützt zweikanaliges DDR3 1800(OC) / 1866(OC) / 2133(OC) / 2200(OC) / 2400(OC) / 2600(OC) / 2667(OC) / 2800(OC) (Hi-Fi Z87W 3D) 4 x DDR3 DIMM-SpeicherSlot, Max. Unterstützung bis zu 32 GB-Speicher Jedes DIMM unterstützt nicht-ECC 512MB/ 1/ 2/ 4/ 8 GB DDR3-Module * Bitte konsultieren Sie www.biostar.com.tw für Speicherunterstützung Liste.
Arbeitsspeicher	INTEL® Z87 & H87: INTEL® B85: 6x SATA 6Gb-Verbindung 4x SATA 6Gb-Verbindung Unterstützt RAID 0,1,10,5, SRT & 2x SATA 3Gb-Verbindung AHCI Unterstützt AHCI
LAN	Realtek RTL 8111G 10/ 100/ 1000 Mb Auto-Negotiation, Halb- / Voll-Duplex-fähig
Audio-Codec	ALC892 7.1 Kanäle, HD-Audio, Biostar Hi-Fi 3D
USB	4x USB 3.0-Port (2 hintere I/Os und 2 via interne Header) 8x USB 2.0-Port (4 hintere I/Os und 4 via interne Header)
Erweiterungsanschlüsse	2x PCI-Slot 2x PCIe 2.0 x1-Slot 1x PCIe 2.0 x16-Slot (x4) 1x PCIe 3.0 x16-Slot (x16)
Hintere I/Os	1x PS/2-Keyboard/ Maus 1x HDMI-Port 1x VGA-Port 1x DVI-Port 1x LAN-Port 4x USB 2.0-Port 2x USB 3.0-Port 6x Audio Jack

Hi-Fi Z87W 3D/Hi-Fi H87W 3D/Hi-Fi B85W 3D

Spezifikationen			
Interne I/Os	<table style="width: 100%; border-collapse: collapse;"> <tr> <td style="width: 50%; vertical-align: top;"> Hi-Fi Z87W 3D & Hi-Fi H87W 3D 6x SATA 6.0Gb/s-Verbindung 2x USB 2.0-Header (jeder Header unterstützt 2 USB 2.0-Ports) 1x USB 3.0-Header (jeder Header unterstützt 2 USB 3.0-Ports) 1x 8-Pin-Stromverbindung 1x 24-Pin-Stromverbindung 1x CPU-Ventilatorverbindung 4x System-Ventilatorverbindung 1x Header für Frontpanel 1x Header für Frontaudio 1x Header für klares CMOS 1x Consumer IR-Header 1x Serieller Port-Header 1x S/PDI-Auswurfsverbindung </td> <td style="width: 50%; vertical-align: top;"> Hi-Fi B85W 3D 4x SATA 6.0Gb/s-Verbindung 2x SATA 3.0Gb/s-Verbindung 2x USB 2.0-Header (jeder Header unterstützt 2 USB 2.0-Ports) 1x USB 3.0-Header (jeder Header unterstützt 2 USB 3.0-Ports) 1x 8-Pin-Stromverbindung 1x 24-Pin-Stromverbindung 1x CPU-Ventilatorverbindung 4x System-Ventilatorverbindung 1x Header für Frontpanel 1x Header für Frontaudio 1x Header für klares CMOS 1x Consumer IR-Header 1x Serieller Port-Header 1x S/PDI-Auswurfsverbindung </td> </tr> </table>	Hi-Fi Z87W 3D & Hi-Fi H87W 3D 6x SATA 6.0Gb/s-Verbindung 2x USB 2.0-Header (jeder Header unterstützt 2 USB 2.0-Ports) 1x USB 3.0-Header (jeder Header unterstützt 2 USB 3.0-Ports) 1x 8-Pin-Stromverbindung 1x 24-Pin-Stromverbindung 1x CPU-Ventilatorverbindung 4x System-Ventilatorverbindung 1x Header für Frontpanel 1x Header für Frontaudio 1x Header für klares CMOS 1x Consumer IR-Header 1x Serieller Port-Header 1x S/PDI-Auswurfsverbindung	Hi-Fi B85W 3D 4x SATA 6.0Gb/s-Verbindung 2x SATA 3.0Gb/s-Verbindung 2x USB 2.0-Header (jeder Header unterstützt 2 USB 2.0-Ports) 1x USB 3.0-Header (jeder Header unterstützt 2 USB 3.0-Ports) 1x 8-Pin-Stromverbindung 1x 24-Pin-Stromverbindung 1x CPU-Ventilatorverbindung 4x System-Ventilatorverbindung 1x Header für Frontpanel 1x Header für Frontaudio 1x Header für klares CMOS 1x Consumer IR-Header 1x Serieller Port-Header 1x S/PDI-Auswurfsverbindung
Hi-Fi Z87W 3D & Hi-Fi H87W 3D 6x SATA 6.0Gb/s-Verbindung 2x USB 2.0-Header (jeder Header unterstützt 2 USB 2.0-Ports) 1x USB 3.0-Header (jeder Header unterstützt 2 USB 3.0-Ports) 1x 8-Pin-Stromverbindung 1x 24-Pin-Stromverbindung 1x CPU-Ventilatorverbindung 4x System-Ventilatorverbindung 1x Header für Frontpanel 1x Header für Frontaudio 1x Header für klares CMOS 1x Consumer IR-Header 1x Serieller Port-Header 1x S/PDI-Auswurfsverbindung	Hi-Fi B85W 3D 4x SATA 6.0Gb/s-Verbindung 2x SATA 3.0Gb/s-Verbindung 2x USB 2.0-Header (jeder Header unterstützt 2 USB 2.0-Ports) 1x USB 3.0-Header (jeder Header unterstützt 2 USB 3.0-Ports) 1x 8-Pin-Stromverbindung 1x 24-Pin-Stromverbindung 1x CPU-Ventilatorverbindung 4x System-Ventilatorverbindung 1x Header für Frontpanel 1x Header für Frontaudio 1x Header für klares CMOS 1x Consumer IR-Header 1x Serieller Port-Header 1x S/PDI-Auswurfsverbindung		
Formfaktor	ATX Formfaktor, 305 mm x 220 mm		
OS-Unterstützung	Windows 7/ 8 Biostar reserves the right to add or remove support for any OS with or without notice.		

Italian

Specificazioni	
Supporto processore	Slot 1150 per processore Intel® Core i7 / i5 / i3 / Pentium / Celeron Alimentazione di Proiezione Termico (TDP – Thermal Design Power): 95Watt * Si prega di consultare www.biostar.com.tw per la lista di supporto del processore.
Tipo scheda	INTEL® Z87 (Hi-Fi Z87W 3D) INTEL® B85 (Hi-Fi B85W 3D) INTEL® H87 (Hi-Fi H87W 3D)
Memoria	Supporta DDR3 1066/ 1333/ 1600 Doppio Canale Supporta DDR3 1800(OC) / 1866(OC) / 2133(OC) / 2200(OC) / 2400(OC) / 2600(OC) / 2667(OC) / 2800(OC) (Hi-Fi Z87W 3D) 4 x DDR3 DIMM Slot di Memoria Supporta fino a 32 GB Memoria Ogni DIMM supporta non-ECC 512MB/ 1/ 2/ 4/ 8 GB DDR3 moduli * Si prega di consultare www.biostar.com.tw per la lista di supporto del memoria.
Memorizzazione	INTEL® Z87 & H87: INTEL® B85: Connettore 6x SATA 6Gb/s Connettore 4x SATA 6Gb/s Supporta RAID 0,1,10,5, SRT & AHCI Connettore 2x SATA 3Gb/s Supporta AHCI
Catena	Realtek RTL 8111G 10/ 100/ 1000 Mb auto negoziazione, capacita di duplex Meta / Completo
Codec Audio	ALC892 Canali Audio di Alta Definizione 7.1, Biostar Hi-Fi 3D
USB	Slot 4x USB 3.0 (2 nei ingressi/ uscite posteriore e 2 da distributori interni) Slot 8x USB 2.0 (4 nei ingressi/ uscite posteriore e 4 da distributori interni)
Slot di espansione	Slot 2x PCI Slot 2x PCIe 2.0 x1 Slot 1x PCIe 2.0 x16 (x4) Slot 1x PCIe 3.0 x16 (x16)
Ingressi/ Uscite Posteriore	Tastiera/ Mouse 1x PS/2 Slot 1x HDMI Slot 1x VGA Slot 1x DVI Slot 1x LAN Slot 4x USB 2.0 Slot 2x USB 3.0 Jack audio 6x

Hi-Fi Z87W 3D/Hi-Fi H87W 3D/Hi-Fi B85W 3D

Specificazioni		
Ingressi/ Uscite Interni	Hi-Fi Z87W 3D & Hi-Fi H87W 3D Connettore 6x SATA 6.0Gb/s Distributore 2x USB 2.0 (ogni distributore supporta 2 slot USB 2.0) Distributore 1x USB 3.0 (ogni distributore supporta 2 slot USB 3.0) Connettore con 8 pin x1 Connettore con 24 pin x1 Connettore Ventilatore processore x1 Connettore Ventilatore Sistema x4 Distributore Pannello Frontale x1 Distributore Audio Frontale x1 Distributore CMOS Diretto x1 Distributore Consumabile IR x1 Distributore Slot Serie x1 Connettore esterno S/PDIF x1	Hi-Fi B85W 3D Connettore 4x SATA 6.0Gb/s Connettore 2x SATA 3.0Gb/s Distributore 2x USB 2.0 (ogni distributore supporta 2 slot USB 2.0) Distributore 1x USB 3.0 (ogni distributore supporta 2 slot USB 3.0) Connettore con 8 pin x1 Connettore con 24 pin x1 Connettore Ventilatore processore x1 Connettore Ventilatore Sistema x4 Distributore Pannello Frontale x1 Distributore Audio Frontale x1 Distributore CMOS Diretto x1 Distributore Consumabile IR x1 Distributore Slot Serie x1 Connettore esterno S/PDIF x1
Fattore di Forma	Fattore di Forma ATX, 305 mm x 220 mm	
Supporto SO	Windows 7/ 8 Biostar si riserva il diritto di aggiungere o ritirare il supporto per qualsiasi SO con o senza preavviso.	

Hi-Fi Z87W 3D/Hi-Fi H87W 3D/Hi-Fi B85W 3D

仕様			
内蔵 I/O	<table border="0" style="width: 100%;"> <tr> <td style="width: 50%; vertical-align: top;"> Hi-Fi Z87W 3D & Hi-Fi H87W 3D 6x SATA 6.0Gb/s コネクタ 2x USB 2.0 ヘッダー (各ヘッダーは、2つの USB 2.0 ポートをサポートしています) 1x USB 3.0 ヘッダー (各ヘッダーは、2つの USB 3.0 ポートをサポートしています) 1x 8-Pin パワー コネクタ 1x 24-Pin パワー コネクタ 1x CPU ファン コネクタ 4x システム ファン コネクタ 1x フロント パネル ヘッダー 1x フロント オーディオ ヘッダー 1x クリア CMOS ヘッダー 1x コンシューマー IR ヘッダー 1x シリアル ポート ヘッダー 1x S/PDIF アウト コネクタ </td> <td style="width: 50%; vertical-align: top;"> Hi-Fi B85W 3D 4x SATA 6.0Gb/s コネクタ 2x SATA 3.0Gb/s コネクタ 2x USB 2.0 ヘッダー (各ヘッダーは 2つの USB 2.0 ポートをサポートしています) 1x USB 3.0 ヘッダー (各ヘッダーは 2つの USB 3.0 ポートをサポートしています) 1x 8-Pin パワー コネクタ 1x 24-Pin パワー コネクタ 1x CPU ファン コネクタ 4x システム ファン コネクタ 1x フロント パネル ヘッダー 1x フロント オーディオ ヘッダー 1x クリア CMOS ヘッダー 1x コンシューマー IR ヘッダー 1x シリアル ポート ヘッダー 1x S/PDIF アウト コネクタ </td> </tr> </table>	Hi-Fi Z87W 3D & Hi-Fi H87W 3D 6x SATA 6.0Gb/s コネクタ 2x USB 2.0 ヘッダー (各ヘッダーは、2つの USB 2.0 ポートをサポートしています) 1x USB 3.0 ヘッダー (各ヘッダーは、2つの USB 3.0 ポートをサポートしています) 1x 8-Pin パワー コネクタ 1x 24-Pin パワー コネクタ 1x CPU ファン コネクタ 4x システム ファン コネクタ 1x フロント パネル ヘッダー 1x フロント オーディオ ヘッダー 1x クリア CMOS ヘッダー 1x コンシューマー IR ヘッダー 1x シリアル ポート ヘッダー 1x S/PDIF アウト コネクタ	Hi-Fi B85W 3D 4x SATA 6.0Gb/s コネクタ 2x SATA 3.0Gb/s コネクタ 2x USB 2.0 ヘッダー (各ヘッダーは 2つの USB 2.0 ポートをサポートしています) 1x USB 3.0 ヘッダー (各ヘッダーは 2つの USB 3.0 ポートをサポートしています) 1x 8-Pin パワー コネクタ 1x 24-Pin パワー コネクタ 1x CPU ファン コネクタ 4x システム ファン コネクタ 1x フロント パネル ヘッダー 1x フロント オーディオ ヘッダー 1x クリア CMOS ヘッダー 1x コンシューマー IR ヘッダー 1x シリアル ポート ヘッダー 1x S/PDIF アウト コネクタ
	Hi-Fi Z87W 3D & Hi-Fi H87W 3D 6x SATA 6.0Gb/s コネクタ 2x USB 2.0 ヘッダー (各ヘッダーは、2つの USB 2.0 ポートをサポートしています) 1x USB 3.0 ヘッダー (各ヘッダーは、2つの USB 3.0 ポートをサポートしています) 1x 8-Pin パワー コネクタ 1x 24-Pin パワー コネクタ 1x CPU ファン コネクタ 4x システム ファン コネクタ 1x フロント パネル ヘッダー 1x フロント オーディオ ヘッダー 1x クリア CMOS ヘッダー 1x コンシューマー IR ヘッダー 1x シリアル ポート ヘッダー 1x S/PDIF アウト コネクタ	Hi-Fi B85W 3D 4x SATA 6.0Gb/s コネクタ 2x SATA 3.0Gb/s コネクタ 2x USB 2.0 ヘッダー (各ヘッダーは 2つの USB 2.0 ポートをサポートしています) 1x USB 3.0 ヘッダー (各ヘッダーは 2つの USB 3.0 ポートをサポートしています) 1x 8-Pin パワー コネクタ 1x 24-Pin パワー コネクタ 1x CPU ファン コネクタ 4x システム ファン コネクタ 1x フロント パネル ヘッダー 1x フロント オーディオ ヘッダー 1x クリア CMOS ヘッダー 1x コンシューマー IR ヘッダー 1x シリアル ポート ヘッダー 1x S/PDIF アウト コネクタ	
	<table border="0" style="width: 100%;"> <tr> <td style="width: 50%;">フォーム ファクタ</td> <td>ATX フォーム ファクタ、305 mm x 220 mm</td> </tr> </table>	フォーム ファクタ	ATX フォーム ファクタ、305 mm x 220 mm
	フォーム ファクタ	ATX フォーム ファクタ、305 mm x 220 mm	
	<table border="0" style="width: 100%;"> <tr> <td style="width: 50%;">サポート OS</td> <td> Windows 7/ 8 Biostar には、通知なしでサポート OS を変更する権限があります。 </td> </tr> </table>	サポート OS	Windows 7/ 8 Biostar には、通知なしでサポート OS を変更する権限があります。
	サポート OS	Windows 7/ 8 Biostar には、通知なしでサポート OS を変更する権限があります。	

Polish

Specyfikacje techniczne	
Obsługa procesora	Gniazdo procesora (Socket) 1150 dla procesorów Intel® Core i7 / i5 / i3 / Pentium / Celeron Moc Wydzielanego Ciepła (TDP - Thermal Design Power): 95Watt * Proszę sprawdzić listę obsługiwanych procesorów na stronie internetowej www.biostar.com.tw
Rodzaj płyty	INTEL® Z87 (Hi-Fi Z87W 3D) INTEL® B85 (Hi-Fi B85W 3D) INTEL® H87 (Hi-Fi H87W 3D)
Pamięć	Obsługa pamięci DDR3 1066/ 1333/ 1600 Dwukanałowa Obsługa pamięci DDR3 1800(OC) / 1866(OC) / 2133(OC) / 2200(OC) / 2400(OC) / 2600(OC) / 2667(OC) / 2800(OC) Dwukanałowa (Hi-Fi Z87W 3D) 4 x DDR3 DIMM Pamięć Gniazda procesora (Slot), Maksymalna wielkość pamięci 32 GB Każdy DIMM obsługuje jeden moduł non-ECC 512MB/ 1/ 2/ 4/ 8 GB DDR3 * Proszę sprawdzić listę obsługiwanych pamięć na stronie internetowej www.biostar.com.tw
Przechowywanie	INTEL® Z87 & H87: INTEL® B85: Złącze 6x SATA 6Gb/s Złącze 4x SATA 6Gb/s Obsługa RAID 0,1,10,5, SRT & AHCI Złącze 2x SATA 3Gb/s Obsługa AHCI
LAN	Układ RTL 8111G 10/ 100/ 1000 Mb auto negocjacja, pojemność duplex Połowe / Pełny
Codec Audio	ALC892 Kanały Audio wysokiej Definicji 7.1, Biostar Hi-Fi 3D
USB	4 x złącza USB 3.0 (2 przez tylne porty wejścia/ wyjścia oraz 2 przez wewnętrzne porty) 8 x złącza USB 2.0 (4 przez tylne porty wejścia/ wyjścia oraz 4 przez wewnętrzne porty)
Złącza rozszerzeń	złącze 2x PCI (Slot) złącze 2x PCIe 2.0 x1 (Slot) złącza 1x PCIe 2.0 x16 (Slot) (x4) złącza 1x PCIe 3.0 x16 (Slot) (x16)
Tylne porty wejścia/ wyjścia	Klawiatura/ Myszka 1x PS/2 Port 1x HDMI (gniazdo) Port 1x VGA Port 1x DVI Port 1x LAN Porty 4x USB 2.0 Porty 2x USB 3.0 Porty audio 6x

Hi-Fi Z87W 3D/Hi-Fi H87W 3D/Hi-Fi B85W 3D

Specyfikacje techniczne		
Wewnętrzne porty wejścia/ wyjścia	Hi-Fi Z87W 3D & Hi-Fi H87W 3D Złącza 6x SATA 6.0Gb/s Złącza 2x USB 2.0 (każde złącze obsługuje dodatkowe 2 porty USB 2.0) Złącze 1x USB 3.0 (każde złącze obsługuje dodatkowe 2 porty USB 3.0) Złącza 8 pionowe x 1 Złącza 24 pionowe x 1 Złącze wentylatora CPU x 1 Złącze wentylatora obudowy x 4 Złącze przedniego panelu x1 Złącze audio przedniego panelu x1 Złącze bezpośrednie CMOS x1 Złącze konsument IR x1 Port szeregowy x1 Port zewnętrzny S/PDIF x1	Hi-Fi B85W 3D Złącza 4x SATA 6.0Gb/s Złącza 2x SATA 3.0Gb/s Złącza 2x USB 2.0 (każde złącze obsługuje dodatkowe 2 porty USB 2.0) Złącze 1x USB 3.0 (każde złącze obsługuje dodatkowe 2 porty USB 3.0) Złącza 8 pionowe x 1 Złącza 24 pionowe x 1 Złącze wentylatora CPU x 1 Złącze wentylatora obudowy x 4 Złącze przedniego panelu x1 Złącze audio przedniego panelu x1 Złącze bezpośrednie CMOS x1 Złącze konsument IR x1 Port szeregowy x1 Port zewnętrzny S/PDIF x1
Obudowa	Obudowa ATX, 305 mm x 220 mm	
Obsługa OS	Windows 7/ 8 Biostar zastrzega sobie prawo do dodania lub wycofania obsługi dla OS, z wypowiedzeniem lub bez wypowiedzenia.	

Portuguese

Especificações	
Suporte Processador	Porta 1150 para processador Intel® Core i7 / i5 / i3 / Pentium / Celeron Alimentação de Design Térmico (TDP – Thermal Design Power): 95Watt * Por favor consulte www.biostar.com.tw para obter uma lista de suporte do processador.
Tipo Placa Mãe	INTEL® Z87 (Hi-Fi Z87W 3D) INTEL® B85 (Hi-Fi B85W 3D) INTEL® H87 (Hi-Fi H87W 3D)
Memória	Suporta DDR3 1066/ 1333/ 1600 Canal Duplo Suporta DDR3(OC) 1800(OC) / 1866(OC) / 2133(OC) / 2200(OC) / 2400(OC) / 2600(OC) / 2667(OC) / 2800(OC) Canal Duplo (Hi-Fi Z87W 3D) 4 x DDR3 DIMM Slot de memória Suporta até 32 GB Memória Cada DIMM suporta non-ECC 512MB/ 1/ 2/ 4/ 8 GB DDR3 módulo * Por favor consulte www.biostar.com.tw para obter uma lista de suporte do memória.
Armazenamento	INTEL® Z87 & H87: INTEL® B85: Conector 6x SATA 6Gb/s Conector 4x SATA 6Gb/s Suporta RAID 0,1,10, 5, SRT & AHCI Conector 2x SATA 3Gb/s Suporta AHCI
LAN	Realtek RTL 8111G 10/ 100/ 1000 Mb auto negociação, capacidade duplex Metade / Cheio
Codec de Audio	ALC892 Canais de Áudio de Alta Definição 7.1, Biostar Hi-Fi 3D
USB	Porta 4x USB 3.0 (2 nas entradas/saídas traseiras e 2 pelos Dispositivos internos) Porta 8x USB 2.0 (4 nas entradas/saídas traseiras e 4 pelos Dispositivos internos)
Slots de expansão	Porta 2x PCI Porta 2x PCIe 2.0 x1 Porta 1x PCIe 2.0 x16 (x4) Porta 1x PCIe 3.0 x16 (x16)
Entradas/Saídas no painel traseiro	Teclado/ Mouse 1x PS/2 Porta 1x HDMI Porta 1x VGA Porta 1x DVI Porta 1x LAN Porta 4x USB 2.0 Porta 2x USB 3.0 Soquete audio 6x

Hi-Fi Z87W 3D/Hi-Fi H87W 3D/Hi-Fi B85W 3D

Especificações		
Conectores na placa	Hi-Fi Z87W 3D & Hi-Fi H87W 3D	Hi-Fi B85W 3D
	Conector 6x SATA 6.0Gb/s	Conector 4x SATA 6.0Gb/s
	Dispositivo 2x USB 2.0 (cada Dispositivo suporta 2 portas USB 2.0)	Conector 2x SATA 3.0Gb/s
	Dispositivo 1x USB 3.0 (cada Dispositivo suporta 2 portas USB 3.0)	Dispositivo 2x USB 2.0 (cada Dispositivo suporta 2 portas USB 2.0)
	Conector de 8 pinos x1	Dispositivo 1x USB 3.0 (cada Dispositivo suporta 2 portas USB 3.0)
	Conector de 24 pinos x1	Conector de 8 pinos x1
	Conector de Ventoinha processador x1	Conector de 24 pinos x1
	Conector de Ventoinha Sistema x4	Conector de Ventoinha processador x1
	Dispositivo Painel Frontal x1	Conector de Ventoinha Sistema x4
	Dispositivo de Audio Frontal x1	Dispositivo Painel Frontal x1
	Dispositivo CMOS Direct x1	Dispositivo de Audio Frontal x1
	Dispositivo Consumível IR x1	Dispositivo CMOS Direct x1
	Dispositivo Porta Série x1	Dispositivo Consumível IR x1
	Conector Externo S/PDIF x1	Dispositivo Porta Série x1
		Conector Externo S/PDIF x1
Fator de Fôrma	Fator de Fôrma ATX, 305 mm x 220 mm	
Suporte OS	Windows 7/ 8 Biostar reserva seu direito de adicionar ou retirar o suporte para qualquer OS com ou sem notificação.	

Hi-Fi Z87W 3D/Hi-Fi H87W 3D/Hi-Fi B85W 3D

Спецификации		
Внутр. Плата ввода-вывода	Hi-Fi Z87W 3D & Hi-Fi H87W 3D Соединитель 6x SATA 6 Гб/с 2 контакта USB 2.0 (каждый контакт поддерживает 2 порта USB 2.0) 1 контакт USB 3.0 (каждый контакт поддерживает 2 порта USB 3.0) 1 8-выводный разъем питания 1 24-выводный разъем питания 1 разъем вентилятора ЦП 4 разъема вентилятора системы 1 контакт передней панели 1 контакт передней аудиопанели 1 контакт микросхемы Clear CMOS 1 инфракрасный пользовательский контакт 1 контакт последовательного порта 1 соединитель S/PDIF-Out	Hi-Fi B85W 3D Соединитель 4x SATA 6 Гб/с Соединитель 2x SATA 3 Гб/с 2 контакта USB 2.0 (каждый контакт поддерживает 2 порта USB 2.0) 1 контакт USB 3.0 (каждый контакт поддерживает 2 порта USB 3.0) 1 8-выводный разъем питания 1 24-выводный разъем питания 1 разъем вентилятора ЦП 4 разъема вентилятора системы 1 контакт передней панели 1 контакт передней аудиопанели 1 контакт микросхемы Clear CMOS 1 инфракрасный пользовательский контакт 1 контакт последовательного порта 1 соединитель S/PDIF-Out
	Конструктив	Форм-фактор ATX, 305 мм x 220 мм
Поддержка ОС	Windows 7/ 8 Biostar оставляет за собой право добавлять или удалять поддержку любой ОС, с уведомлением или без.	

Spanish

Especificaciones	
Compatibilidad con el procesador	Ranura 1150 para procesador Intel® Core i7 / i5 / i3 / Pentium / Celeron Alimentación de Proyección Térmica (TDP – Thermal Design Power): 95Watt *Por favor consultar con www.biostar.com.tw para la lista de compatibilidad con el procesador.
Tipo de Placa	INTEL® Z87 (Hi-Fi Z87W 3D) INTEL® B85 (Hi-Fi B85W 3D) INTEL® H87 (Hi-Fi H87W 3D)
Memoria	Soporta DDR3 1066/ 1333/ 1600 Doble Canal Soporta DDR3 1800(OC) / 1866(OC) / 2133(OC) / 2200(OC) / 2400(OC) / 2600(OC) / 2667(OC) / 2800(OC) Doble Canal (Hi-Fi Z87W 3D) 4x DDR3 DIMM Ranura de memoria Soporta hasta 32 GB Memoria Cada DIMM soporta un modulo non-ECC 512MB/ 1/ 2/ 4/ 8 GB DDR3 *Por favor consultar con www.biostar.com.tw para la lista de compatibilidad con el memoria.
Almacenamiento de información	INTEL® Z87 & H87: INTEL® B85: Conector 6x SATA 6Gb/s Conector 4x SATA 6Gb/s Soporta RAID 0,1,10,5, SRT & AHCI Conector 2x SATA 3Gb/s Soporta AHCI
LAN	Realtek RTL 8111G 10/ 100/ 1000 Mb/s auto negociación, capacidad dúplex Mitad/Completo
Códec Audio	ALC892 Canales Audio de Alta Definición 7.1, Biostar Hi-Fi 3D
USB	Ranura 4x USB 3.0 (2 en las entrada/salidas posteriores y 2 por los distribuidores internos) Ranura 8x USB 2.0 (4 en las entrada/salidas posteriores y 4 por los distribuidores internos)
Ranuras de Extinción	Ranura 2x PCI Ranura 2x PCIe 2.0 x1 Ranura 1x PCIe 2.0 x16 (x4) Ranura 1x PCIe 3.0 x16 (x16)
Panel trasero de E/S	Teclado/ Ratón 1x PS/2 Ranura 1x HDMI Ranura 1x VGA Ranura 1x DVI Ranura 1x LAN Ranura 4x USB 2.0 Ranura 2x USB 3.0 Socket audio 6x

Hi-Fi Z87W 3D/Hi-Fi H87W 3D/Hi-Fi B85W 3D

Especificaciones																															
Conectores en placa	<table border="0" style="width: 100%;"> <tr> <td style="width: 50%;">Hi-Fi Z87W 3D & Hi-Fi H87W 3D</td> <td style="width: 50%;">Hi-Fi B85W 3D</td> </tr> <tr> <td>Conector 6x SATA 6Gb's</td> <td>Conector 4x SATA 6Gb's</td> </tr> <tr> <td>Distribuidor 2x USB 2.0 (cada distribuidor soporta 2 ranuras USB 2.0)</td> <td>Conector 2x SATA 3Gb's</td> </tr> <tr> <td>Distribuidor 1x USB 3.0 (cada distribuidor soporta 2 ranuras USB 3.0)</td> <td>Distribuidor 2x USB 2.0 (cada distribuidor soporta 2 ranuras USB 2.0)</td> </tr> <tr> <td>Conector con 8 patillas x1</td> <td>Distribuidor 1x USB 3.0 (cada distribuidor soporta 2 ranuras USB 3.0)</td> </tr> <tr> <td>Conector con 24 patillas x1</td> <td>Conector con 8 patillas x1</td> </tr> <tr> <td>Conector Ventilador procesador x1</td> <td>Conector con 24 patillas x1</td> </tr> <tr> <td>Conector Ventilador Sistema x4</td> <td>Conector Ventilador procesador x1</td> </tr> <tr> <td>Distribuidor Panel Frontal x1</td> <td>Conector Ventilador Sistema x4</td> </tr> <tr> <td>Distribuidor Audio Frontal x1</td> <td>Distribuidor Panel Frontal x1</td> </tr> <tr> <td>Distribuidor CMOS Directo x1</td> <td>Distribuidor Audio Frontal x1</td> </tr> <tr> <td>Distribuidor Consumible IR x1</td> <td>Distribuidor CMOS Directo x1</td> </tr> <tr> <td>Distribuidor Ranura Serie x1</td> <td>Distribuidor Consumible IR x1</td> </tr> <tr> <td>Conector Externo S/PDIF x1</td> <td>Distribuidor Ranura Serie x1</td> </tr> <tr> <td></td> <td>Conector Externo S/PDIF x1</td> </tr> </table>	Hi-Fi Z87W 3D & Hi-Fi H87W 3D	Hi-Fi B85W 3D	Conector 6x SATA 6Gb's	Conector 4x SATA 6Gb's	Distribuidor 2x USB 2.0 (cada distribuidor soporta 2 ranuras USB 2.0)	Conector 2x SATA 3Gb's	Distribuidor 1x USB 3.0 (cada distribuidor soporta 2 ranuras USB 3.0)	Distribuidor 2x USB 2.0 (cada distribuidor soporta 2 ranuras USB 2.0)	Conector con 8 patillas x1	Distribuidor 1x USB 3.0 (cada distribuidor soporta 2 ranuras USB 3.0)	Conector con 24 patillas x1	Conector con 8 patillas x1	Conector Ventilador procesador x1	Conector con 24 patillas x1	Conector Ventilador Sistema x4	Conector Ventilador procesador x1	Distribuidor Panel Frontal x1	Conector Ventilador Sistema x4	Distribuidor Audio Frontal x1	Distribuidor Panel Frontal x1	Distribuidor CMOS Directo x1	Distribuidor Audio Frontal x1	Distribuidor Consumible IR x1	Distribuidor CMOS Directo x1	Distribuidor Ranura Serie x1	Distribuidor Consumible IR x1	Conector Externo S/PDIF x1	Distribuidor Ranura Serie x1		Conector Externo S/PDIF x1
	Hi-Fi Z87W 3D & Hi-Fi H87W 3D	Hi-Fi B85W 3D																													
	Conector 6x SATA 6Gb's	Conector 4x SATA 6Gb's																													
	Distribuidor 2x USB 2.0 (cada distribuidor soporta 2 ranuras USB 2.0)	Conector 2x SATA 3Gb's																													
	Distribuidor 1x USB 3.0 (cada distribuidor soporta 2 ranuras USB 3.0)	Distribuidor 2x USB 2.0 (cada distribuidor soporta 2 ranuras USB 2.0)																													
	Conector con 8 patillas x1	Distribuidor 1x USB 3.0 (cada distribuidor soporta 2 ranuras USB 3.0)																													
	Conector con 24 patillas x1	Conector con 8 patillas x1																													
	Conector Ventilador procesador x1	Conector con 24 patillas x1																													
	Conector Ventilador Sistema x4	Conector Ventilador procesador x1																													
	Distribuidor Panel Frontal x1	Conector Ventilador Sistema x4																													
	Distribuidor Audio Frontal x1	Distribuidor Panel Frontal x1																													
	Distribuidor CMOS Directo x1	Distribuidor Audio Frontal x1																													
	Distribuidor Consumible IR x1	Distribuidor CMOS Directo x1																													
	Distribuidor Ranura Serie x1	Distribuidor Consumible IR x1																													
Conector Externo S/PDIF x1	Distribuidor Ranura Serie x1																														
	Conector Externo S/PDIF x1																														
Factor de Forma	Factor de Forma ATX, 305 mm x 220 mm																														
Soporte OS	Windows 7/ 8 Biostar reserva su derecho de añadir o retirar el soporte para cada OS con o sin notificación.																														

2013/07/11